

# MilesTek®

an INFINIT® brand



**2021 Product Guide**  
Military & Aerospace Components at the Ready

Same-Day Shipping | +1 (866) 524-1553 | [milestek.com](http://milestek.com)

## Your Military & Aerospace Interconnect Specialists

Since 1981, MilesTek customers have come to expect more than just products—they expect answers & support that will help them solve all their installation or project questions.

With quick turnaround and same-day shipping for most of the high reliability products we carry, you can rely on MilesTek to help meet your project deadlines.

### Markets We Serve:

- Commercial & Military Avionics
- Broadcast & DS3/Telecom
- Military and Industrial Networking
- Aerospace Communications

### MilesTek Advantages:

- Large In-Stock Inventories
- Same-Day Shipping
- Prototype Development
- CAD Design Capabilities
- Multiple Testing Solutions
- Expert Technical Support
- ISO 9001:2015 Registered

From high-volume production, to low-volume customized products, MilesTek is your source for military, aerospace, communications and industrial interconnect solutions.





## Stocking over 10,000 Products Covering a Wide Breadth of Connectivity Needs:

- Coaxial Cable Assemblies and Harnesses
- Military Avionics/ MIL-STD-1553B
- Bulk Cable by the Foot
- Data Bus Couplers
- Custom Cable Assemblies, Panel Assemblies & Tools
- Twinaxial
- Triaxial
- LSZH Assemblies
- Connectors, Adapters & Terminators
- Switching Devices
- Rugged Ethernet, USB and Fiber Assemblies



**Technical Expertise • Customer Service • Unbeatable Value**

# TABLE OF CONTENTS

## 4 - 25 ..... MIL-STD-1553B

NEW PRODUCTS ADDED

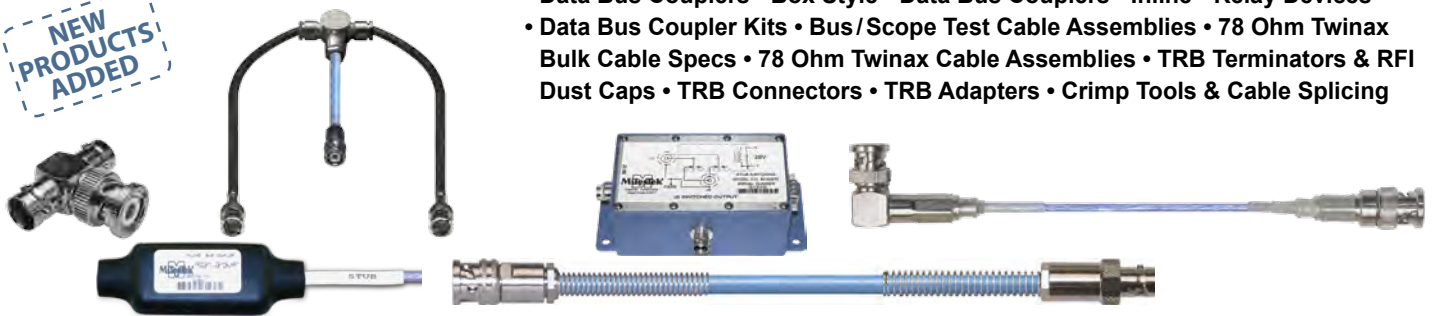

- Data Bus Couplers - Box Style • Data Bus Couplers - Inline • Relay Devices
- Data Bus Coupler Kits • Bus/Scope Test Cable Assemblies • 78 Ohm Twinax Bulk Cable Specs • 78 Ohm Twinax Cable Assemblies • TRB Terminators & RFI Dust Caps • TRB Connectors • TRB Adapters • Crimp Tools & Cable Splicing

## 26 - 28 ..... SUBMINIATURE



- TRS Data Bus Couplers - Box Style • TRS 78 Ohm Twinax Cable Assemblies
- TRS Subminiature Size Connectors • TRS Crimp Tools and Compatibility Information

## 29 - 32 ..... TWINAXIAL



- 100 Ohm Twinax Bulk Cable Specs • 100 Ohm Twinax Cable Assemblies • 100 Ohm Bus Terminators • 100 Ohm Twinax Connectors • 124 Ohm Twinax Bulk Cable Specs • 124 Ohm Twinax Cable Assemblies • 124 Ohm Twinax Connectors

## 34 - 38 ..... TRIAXIAL



- Bulk Cable Specs - 50 & 75 Ohm Triax • 50 Ohm Triax Cable Assemblies
- 50 Ohm Triax Connectors • 75 Ohm Triax Cable Assemblies
- 75 Ohm Triax Connectors

## 39 ..... D-SUB

NEW PRODUCTS ADDED



- Low Smoke Zero Halogen (LSZH) Cable Assemblies • DB9 - DB25 Male to Female Connectors • Field Termination Connectors



# TABLE OF CONTENTS

## 40.....D-Sub Cables, D-Sub Connectors, Ethernet Cable

---



DSA00012



DSB00033



T6A00007

## 41.....Ethernet Adapters, USB Cables/Connectors & GPIB Cables

---



T6C00024

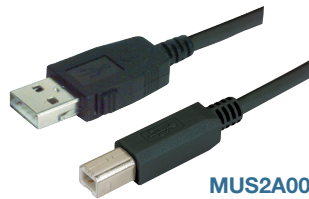

MUS2A00018



MGPA00001

## 42.....SCSI Cables, A/V Cables, AV Adapters

---



SZA00001



MDA00015



10-03900

## 43.....Fiber Optic Cables & Connectors, Racks & Panels, & Power Cords

---



FSA00001



FYK00004



REF00255



MPPA00011

# MIL-STD-1553B | Data Bus Couplers

## 1-Stub Data Bus Couplers



**90-50201**  
**MSX000001**

Part #	
90-50201	
MSX000001	
Feature	Specification
bus & stub jacks	TRB 3-lug jacks
tech note	non-terminated
bus termination	none



**90-50211**  
**MSX000002**

Part #	
90-50211	
MSX000002	
Feature	Specification
bus & stub jacks	TRB 3-lug jacks
tech note	single-terminated
bus termination	none



**90-51211**  
**MSX000003**

Part #	
90-51211	
MSX000003	
Feature	Specification
bus & stub jacks	TRB 3-lug jacks
tech note	single-terminated
bus termination	one 78.7 ohm resistor



**90-52211**  
**MSX000004**

Part #	
90-52211	
MSX000004	
Feature	Specification
bus & stub jacks	TRB 3-lug jacks
tech note	single-terminated
bus termination	one 78.7 ohm resistor



**90-50231**  
**MSX000005**

Part #	
90-50231	
MSX000005	
Feature	Specification
bus & stub jacks	TRB 3-lug jacks
tech note	single-terminated
bus termination	one 78.7 ohm resistor

## 2-Stub Data Bus Couplers



**90-50202**  
**MSX000006**

Part #	
90-50202	
MSX000006	
Feature	Specification
bus & stub jacks	TRB 3-lug jacks
tech note	non-terminated
bus termination	none



**90-50212**  
**MSX000007**

Part #	
90-50212	
MSX000007	
Feature	Specification
bus & stub jacks	TRB 3-lug jacks
tech note	single-terminated
bus termination	one 78.7 ohm resistor



**90-51212**  
**MSX000008**

Part #	
90-51212	
MSX000008	
Feature	Specification
bus & stub jacks	TRB 3-lug jacks
tech note	single-terminated
bus termination	one 78.7 ohm resistor



**90-52212**  
**MSX000009**

Part #	
90-52212	
MSX000009	
Feature	Specification
bus & stub jacks	TRB 3-lug jacks
tech note	single-terminated
bus termination	one 78.7 ohm resistor



**90-50222**  
**MSX000010**

Part #	
90-50222	
MSX000010	
Feature	Specification
bus & stub jacks	TRB 3-lug jacks
tech note	dual-terminated
bus termination	two 78.7 ohm resistors

# TRB Cable Assemblies | MIL-STD-1553B

## Plenum Cable Assemblies

Item #	Description
MSA00096-12N	Plenum Cable Assembly TRB 3-Slot Plug to Plug MIL-STD-1553 .242" O.D. +125C 78 Ohm Twinaxial Shielded Twisted Pair 1'
MSA00097-12N	Plenum Cable Assembly TRB 3-Slot Plug to Blunt MIL-STD-1553 .242" O.D. +125C 78 Ohm Twinaxial Shielded Twisted Pair 1'
MSA00098-12N	Plenum Cable Assembly TRB 3-Slot Plug to 3-Lug Cable Jack MIL-STD-1553 .242" O.D. +125C 78 Ohm Twinaxial Shielded Twisted Pair 1'
MSA00099-12N	Plenum Cable Assembly TRB 3-Slot Plug to Non-Insulated Bulk Head 3-Lug Cable Jack MIL-STD-1553 .242" O.D. +125C 78 Ohm Twinaxial Shielded Twisted Pair 1'
MSA00100-12N	Plenum Cable Assembly TRB 3-Slot Plug to Insulated Bulk Head 3-Lug Cable Jack MIL-STD-1553 .242" O.D. +125C 78 Ohm Twinaxial Shielded Twisted Pair 1'
MSA00101-12N	Plenum Cable Assembly TRB 3-Slot Plug to Plug with Bend Reliefs MIL-STD-1553 .242" O.D. +125C 78 Ohm Twinaxial Shielded Twisted Pair 1'
MSA00102-12N	Plenum Cable Assembly TRB 3-Slot Plug with Bend Relief to Blunt MIL-STD-1553 .242" O.D. +125C 78 Ohm Twinaxial Shielded Twisted Pair 1'
MSA00103-12N	Plenum Cable Assembly TRB 3-Slot Plug to 3-Lug Cable Jack with Bend Reliefs MIL-STD-1553 .242" O.D. +125C 78 Ohm Twinaxial Shielded Twisted Pair 1'
MSA00104-12N	Plenum Cable Assembly TRB 3-Slot Plug to Non-Insulated Bulk Head 3-Lug Cable Jack with Bend Reliefs MIL-STD-1553 .242" O.D.+125C 78 Ohm Twinaxial Shielded Twisted Pair 1'
MSA00105-12N	Plenum Cable Assembly TRB 3-Slot Plug to Insulated Bulk Head 3-Lug Cable Jack with Bend Reliefs MIL-STD-1553 .242" O.D. +125C 78 Ohm Twinaxial Shielded Twisted Pair 1'
MSA00106-12N	Plenum Cable Assembly TRB 3-Lug Cable Jack to Jack MIL-STD-1553 .242" O.D. +125C 78 Ohm Twinaxial Shielded Twisted Pair 1'
MSA00107-12N	Plenum Cable Assembly TRB Non-Insulated Bulk Head 3-Lug Cable Jack to Jack MIL-STD-1553 .242" O.D. +125C 78 Ohm Twinaxial Shielded Twisted Pair 1'
MSA00108-12N	Plenum Cable Assembly TRB Insulated Bulk Head Jack 3-Lug Cable Jack to Jack MIL-STD-1553 .242" O.D. +125C 78 Ohm Twinaxial Shielded Twisted Pair 1'
MSA00109-12N	Plenum Cable Assembly TRB 3-Lug Cable Jack to Jack with Bend Reliefs MIL-STD-1553 .242" O.D. +125C 78 Ohm Twinaxial Shielded Twisted Pair 1'
MSA00110-12N	Plenum Cable Assembly TRB Non-Insulated Bulk Head 3-Lug Cable Jack to Jack with Bend Reliefs MIL-STD-1553 .242" O.D. +125C 78 Ohm Twinaxial Shielded Twisted Pair 1'
MSA00111-12N	Plenum Cable Assembly TRB Insulated Bulk Head 3-Lug Cable Jack to Jack with Bend Relief MIL-STD-1553 .242" O.D. +125C 78 Ohm Twinaxial Shielded Twisted Pair 1'



See our website, [MilesTek.com](http://MilesTek.com) to view all of our products.



# MIL-STD-1553B | 3-Stub Data Bus Couplers



**90-50203  
MSX000011**



**90-50213  
MSX000012**



**90-51213  
MSX000013**



**90-52213  
MSX000014**



**90-50223  
MSX000015**

Part #	Feature	Specification
<b>90-50203</b>	bus & stub jacks	TRB 3-lug jacks
<b>MSX000011</b>	tech note	<b>non-terminated</b>
	bus termination	none

Part #	Feature	Specification
<b>90-50213</b>	bus & stub jacks	TRB 3-lug jacks
<b>MSX000012</b>	tech note	<b>single-terminated</b>
	bus termination	one 78.7 ohm resistor

Part #	Feature	Specification
<b>90-51213</b>	bus & stub jacks	TRB 3-lug jacks
<b>MSX000013</b>	tech note	<b>single-terminated</b>
	bus termination	one 78.7 ohm resistor

Part #	Feature	Specification
<b>90-52213</b>	bus & stub jacks	TRB 3-lug jacks
<b>MSX000014</b>	tech note	<b>single-terminated</b>
	bus termination	one 78.7 ohm resistor

Part #	Feature	Specification
<b>90-50223</b>	bus & stub jacks	TRB 3-lug jacks
<b>MSX000015</b>	tech note	<b>dual-terminated</b>
	bus termination	two 78.7 ohm resistors

See our website, [MilesTek.com](http://MilesTek.com) for detailed information.



## Halogen Free Cable Assemblies

Item #	Description
<b>MSA00224-12N</b>	Halogen Free Cable Assembly TRB 3-Slot Plug to Plug MIL-STD-1553 .242" O.D. -30C +80C 78 Ohm Twinaxial Shielded Twisted Pair 1'
<b>MSA00225-12N</b>	Halogen Free Cable Assembly TRB 3-Slot Plug to Blunt MIL-STD-1553 .242" O.D. -30C +80C 78 Ohm Twinaxial Shielded Twisted Pair 1'
<b>MSA00226-12N</b>	Halogen Free Cable Assembly TRB 3-Slot Plug to 3-Lug Cable Jack MIL-STD-1553 .242" O.D. -30C +80C 78 Ohm Twinaxial Shielded Twisted Pair 1'
<b>MSA00227-12N</b>	Halogen Free Cable Assembly TRB 3-Slot Plug to Non-Insulated Bulk Head 3-Lug Cable Jack MIL-STD-1553 .242" O.D. -30C +80C 78 Ohm Twinaxial Shielded Twisted Pair 1'

Custom connectorization and configuration options available.

# 4-Stub Data Bus Couplers | MIL-STD-1553B

Part #	Feature	Specification
90-50204	bus & stub jacks	TRB 3-lug jacks
MSX000016	tech note	<b>non-terminated</b>
	bus termination	none



**90-50204  
MSX000016**

Part #	Feature	Specification
90-50214	bus & stub jacks	TRB 3-lug jacks
MSX000017	tech note	<b>single-terminated</b>
	bus termination	one 78.7 ohm resistor



**90-50214  
MSX000017**

Part #	Feature	Specification
90-51214	bus & stub jacks	TRB 3-lug jacks
MSX000018	tech note	<b>single-terminated</b>
	bus termination	one 78.7 ohm resistor



**90-51214  
MSX000018**

Part #	Feature	Specification
90-52214	bus & stub jacks	TRB 3-lug jacks
MSX000019	tech note	<b>single-terminated</b>
	bus termination	one 78.7 ohm resistor



**90-52214  
MSX000019**

Part #	Feature	Specification
90-50224	bus & stub jacks	TRB 3-lug jacks
MSX000020	tech note	<b>dual-terminated</b>
	bus termination	two 78.7 ohm resistors



**90-50224  
MSX000020**

See our website, [MilesTek.com](http://MilesTek.com) for detailed information.

## Halogen Free Cable Assemblies

Item #	Description
MSA00228-12N	Halogen Free Cable Assembly TRB 3-Slot Plug to Insulated Bulk Head 3-Lug Cable Jack MIL-STD-1553 .242" O.D. -30C +80C 78 Ohm Twinaxial Shielded Twisted Pair 1'
MSA00234-12N	Halogen Free Cable Assembly TRB 3-Lug Cable Jack to Jack MIL-STD-1553 .242" O.D. -30C +80C 78 Ohm Twinaxial Shielded Twisted Pair 1'
MSA00229-12N	Halogen Free Cable Assembly TRB 3-Slot Plug to Plug with Bend Reliefs MIL-STD-1553 .242" O.D. -30C +80C 78 Ohm Twinaxial Shielded Twisted Pair 1'
MSA00230-12N	Halogen Free Cable Assembly TRB 3-Slot Plug with Bend Relief to Blunt MIL-STD-1553 .242" O.D. -30C +80C 78 Ohm Twinaxial Shielded Twisted Pair 1'

Custom connectorization and configuration options available.



# MIL-STD-1553B | 5-Stub Data Bus Couplers



**90-50205  
MSX000021**



**90-50215  
MSX000022**



**90-51215  
MSX000023**



**90-52215  
MSX000024**



**90-50225  
MSX000025**

Part #	Feature	Specification
<b>90-50205</b>	bus & stub jacks	TRB 3-lug jacks
<b>MSX000021</b>	tech note	<b>non-terminated</b>
	bus termination	none

Part #	Feature	Specification
<b>90-50215</b>	bus & stub jacks	TRB 3-lug jacks
<b>MSX000022</b>	tech note	<b>single-terminated</b>
	bus termination	one 78.7 ohm resistor

Part #	Feature	Specification
<b>90-51215</b>	bus & stub jacks	TRB 3-lug jacks
<b>MSX000023</b>	tech note	<b>single-terminated</b>
	bus termination	one 78.7 ohm resistor

Part #	Feature	Specification
<b>90-52215</b>	bus & stub jacks	TRB 3-lug jacks
<b>MSX000024</b>	tech note	<b>single-terminated</b>
	bus termination	one 78.7 ohm resistor

Part #	Feature	Specification
<b>90-50225</b>	bus & stub jacks	TRB 3-lug jacks
<b>MSX000025</b>	tech note	<b>dual-terminated</b>
	bus termination	two 78.7 ohm resistors

## Halogen Free Cable Assemblies



Item #	Description
<b>MSA00231-12N</b>	Halogen Free Cable Assembly TRB 3-Slot Plug to 3-Lug Cable Jack with Bend Reliefs MIL-STD-1553 .242" O.D. -30C +80C 78 Ohm Twinaxial Shielded twisted pair 1'
<b>MSA00232-12N</b>	Halogen Free Cable Assembly TRB 3-Slot Plug to Non-Insulated Bulk Head 3-Lug Cable Jack with Bend Reliefs MIL-STD-1553 .242" O.D. -30C +80C 78 Ohm Twinaxial Shielded twisted pair 1'
<b>MSA00233-12N</b>	Halogen Free Cable Assembly TRB 3-Slot Plug to Insulated Bulk Head 3-Lug Cable Jack with Bend Reliefs MIL-STD-1553 .242" O.D. -30C +80C 78 Ohm Twinaxial Shielded twisted pair 1'
<b>MSA00235-12N</b>	Halogen Free Cable Assembly TRB Non-Insulated Bulk Head 3-Lug Cable Jack to Jack MIL-STD-1553 .242" O.D. -30C +80C 78 Ohm Twinaxial Shielded twisted pair 1'

Custom connectorization and configuration options available.



# 6-Stub Data Bus Couplers | MIL-STD-1553B

Part #	1 Piece Price	Feature	Specification
90-50206		bus & stub jacks	TRB 3-lug jacks
MSX000026		tech note	<b>non-terminated</b>
		bus termination	none



**90-50206  
MSX000026**

Part #	Feature	Specification
90-50216	bus & stub jacks	TRB 3-lug jacks
MSX000027	tech note	<b>single-terminated</b>
	bus termination	one 78.7 ohm resistor



**90-50216  
MSX000027**

Part #	Feature	Specification
90-51216	bus & stub jacks	TRB 3-lug jacks
MSX000028	tech note	<b>single-terminated</b>
	bus termination	one 78.7 ohm resistor



**90-51216  
MSX000028**

Part #	Feature	Specification
90-52216	bus & stub jacks	TRB 3-lug jacks
MSX000029	tech note	<b>single-terminated</b>
	bus termination	one 78.7 ohm resistor



**90-52216  
MSX000029**

Part #	Feature	Specification
90-50226	bus & stub jacks	TRB 3-lug jacks
MSX000030	tech note	<b>dual-terminated</b>
	bus termination	two 78.7 ohm resistors



**90-50226  
MSX000030**

## Halogen Free Cable Assemblies

Item #	Description
MSA00236-12N	Halogen Free Cable Assembly TRB Insulated Bulk Head Jack 3-Lug Cable Jack to Jack MIL-STD-1553 .242" O.D. -30C +80C 78 Ohm Twinaxial Shielded twisted pair 1'
MSA00237-12N	Halogen Free Cable Assembly TRB 3-Lug Cable Jack to Jack with Bend Reliefs MIL-STD-1553 .242" O.D. -30C +80C 78 Ohm Twinaxial Shielded twisted pair 1'
MSA00238-12N	Halogen Free Cable Assembly TRB Non-Insulated Bulk Head 3-Lug Cable Jack to Jack with Bend Reliefs MIL-STD-1553 .242" O.D. -30C +80C 78 Ohm Twinaxial Shielded twisted pair 1'
MSA00239-12N	Halogen Free Cable Assembly TRB Insulated Bulk Head 3-Lug Cable Jack to Jack with Bend Relief MIL-STD-1553 .242" O.D. -30C +80C 78 Ohm Twinaxial Shielded twisted pair 1'



Custom connectorization and configuration options available.

# MIL-STD-1553B | 7-Stub Data Bus Couplers



**90-50207  
MSX000031**



**90-50217  
MSX000032**



**90-51217  
MSX000033**



**90-52217  
MSX000034**



**90-50227  
MSX000035**

Part #	Feature	Specification
<b>90-50207</b>	bus & stub jacks	TRB 3-lug jacks
<b>MSX000031</b>	tech note	<b>non-terminated</b>
	bus termination	none

Part #	Feature	Specification
<b>90-50217</b>	bus & stub jacks	TRB 3-lug jacks
<b>MSX000032</b>	tech note	<b>single-terminated</b>
	bus termination	one 78.7 ohm resistor

Part #	Feature	Specification
<b>90-51217</b>	bus & stub jacks	TRB 3-lug jacks
<b>MSX000033</b>	tech note	<b>single-terminated</b>
	bus termination	one 78.7 ohm resistor

Part #	Feature	Specification
<b>90-52217</b>	bus & stub jacks	TRB 3-lug jacks
<b>MSX000034</b>	tech note	<b>single-terminated</b>
	bus termination	one 78.7 ohm resistor

Part #	Feature	Specification
<b>90-50227</b>	bus & stub jacks	TRB 3-lug jacks
<b>MSX000035</b>	tech note	<b>dual-terminated</b>
	bus termination	two 78.7 ohm resistors

## TRB Bus & Stub Terminators - Without Chain



Terminator	Description	Resistor Value
<b>10-06403-025</b>	bus terminator, without chain	78 ohm
<b>10-06403-033</b>	stub terminator, without chain	1000 ohm
<b>10-06403-044</b>	stub terminator, without chain	2000 ohm
<b>10-06403-024</b>	stub terminator, without chain	3000 ohm

## TRB Bus & Stub Terminators - With 3 Inch Stainless Steel Chain



Terminator	Description	Resistor Value
<b>10-06403-060</b>	bus terminator, 3" chain	78 ohm
<b>10-06403-065</b>	stub terminator, 3" chain	2000 ohm
<b>10-06403-064</b>	stub terminator, 3" chain	3000 ohm

Custom connectorization and configuration options available.

# 8-Stub Data Bus Couplers | MIL-STD-1553B

Part #	Feature	Specification
90-50208	bus & stub jacks	TRB 3-lug jacks
MSX000036	tech note	<b>non-terminated</b>
	bus termination	none



**90-50208  
MSX000036**

Part #	Feature	Specification
90-50218	bus & stub jacks	TRB 3-lug jacks
MSX000037	tech note	<b>single-terminated</b>
	bus termination	one 78.7 ohm resistor



**90-50218  
MSX000037**

Part #	Feature	Specification
90-51218	bus & stub jacks	TRB 3-lug jacks
MSX000038	tech note	<b>single-terminated</b>
	bus termination	one 78.7 ohm resistor



**90-51218  
MSX000038**

Part #	Feature	Specification
90-52218	bus & stub jacks	TRB 3-lug jacks
MSX000039	tech note	<b>single-terminated</b>
	bus termination	one 78.7 ohm resistor



**90-52218  
MSX000039**

Part #	Feature	Specification
90-50228	bus & stub jacks	TRB 3-lug jacks
MSX000040	tech note	<b>dual-terminated</b>
	bus termination	two 78.7 ohm resistors



**90-50228  
MSX000040**

## TRB Bus & Stub Terminators - With 6 Inch Stainless Steel Chain

Terminator	Description	Resistor Value
10-06403-026	bus terminator, 6" chain	78 ohm
10-06403-034	stub terminator, 6" chain	1000 ohm
10-06403-042	stub terminator, 6" chain	2000 ohm
10-06403-038	stub terminator, 6" chain	3000 ohm

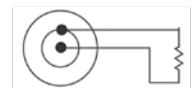

WIRE-WOUND  
RESISTOR

## TRB RFI Dust Protection Caps - Stainless Steel Chain Options

RFI Cap	Description
10-06300	RFI dust cap, without chain
10-06304	RFI dust cap, 3" chain
10-06303	RFI dust cap, 6" chain



10-06300



10-06304



10-06303

Custom connectorization and configuration options available.



# MIL-STD-1553B | Inline Bus Couplers

## 1-Stub Inline Bus Couplers



90-50251-12

**Part #**

**90-50251-12**

Feature	Specification
bus & stub jacks	12" M17/176-00002 blunt ends
tech note	<b>non-terminated</b>
bus termination	none
nominal unit weight	1.50 oz (42.52 g)



90-50261-12

**Part #**

**90-50261-12**

Feature	Specification
bus & stub jacks	12" M17/176-00002 blunt ends
tech note	<b>single-terminated</b>
bus termination	one 78.7 ohm resistor
nominal unit weight	1.10 oz (31.18 g)



90-50361-12

**Part #**

**90-50361-12**

Feature	Specification
bus & stub jacks	12" M17/176-00002 blunt ends
tech note	<b>single-terminated</b>
bus termination	one 78.7 ohm resistor
nominal unit weight	1.10 oz (31.18 g)



90-50461-12

**Part #**

**90-50461-12**

Feature	Specification
bus & stub jacks	12" M17/176-00002 blunt ends
tech note	<b>dual-terminated</b>
bus termination	two 78.7 ohm resistor
nominal unit weight	0.70 oz (19.74 g)

## 2-Stub Inline Bus Couplers



90-50252-12

**Part #**

**90-50252-12**

Feature	Specification
bus & stub jacks	12" M17/176-00002 blunt ends
tech note	<b>non-terminated</b>
bus termination	none
nominal unit weight	1.90 oz (53.86 g)



90-50262-12

**Part #**

**90-50262-12**

Feature	Specification
bus & stub jacks	12" M17/176-00002 blunt ends
tech note	<b>single-terminated</b>
bus termination	one 78.7 ohm resistor
nominal unit weight	1.50 oz (42.52 g)



90-50362-12

**Part #**

**90-50362-12**

Feature	Specification
bus & stub jacks	12" M17/176-00002 blunt ends
tech note	<b>single-terminated</b>
bus termination	one 78.7 ohm resistor
nominal unit weight	1.50 oz (42.52 g)



90-50462-12

**Part #**

**90-50462-12**

Feature	Specification
bus & stub jacks	12" M17/176-00002 blunt ends
tech note	<b>dual-terminated</b>
bus termination	two 78.7 ohm resistor
nominal unit weight	1.10 oz (31.18 g)



90-50562-12

**Part #**

**90-50562-12**

Feature	Specification
bus & stub jacks	12" M17/176-00002 blunt ends
tech note	<b>dual-terminated</b>
bus termination	two 78.7 ohm resistor
nominal unit weight	1.10 oz (31.18 g)

## 3-Stub Inline Bus Couplers

Part #	
<b>90-50253-12</b>	
Feature	Specification
bus & stub jacks	12" M17/176-00002 blunt ends
tech note	<b>non-terminated</b>
bus termination	none
nominal unit weight	2.70 oz (76.54 g)

Part #	
<b>90-50363-12</b>	
Feature	Specification
bus & stub jacks	12" M17/176-00002 blunt ends
tech note	<b>single-terminated</b>
bus termination	one 78.7 ohm resistor
nominal unit weight	2.30 oz (65.20 g)

Part #	
<b>90-50563-12</b>	
Feature	Specification
bus & stub jacks	12" M17/176-00002 blunt ends
tech note	<b>dual-terminated</b>
bus termination	two 78.7 ohm resistor
nominal unit weight	1.90 oz (53.86 g)

Part #	
<b>90-50263-12</b>	
Feature	Specification
bus & stub jacks	12" M17/176-00002 blunt ends
tech note	<b>single-terminated</b>
bus termination	one 78.7 ohm resistor
nominal unit weight	2.30 oz (65.20 g)

Part #	
<b>90-50463-12</b>	
Feature	Specification
bus & stub jacks	12" M17/176-00002 blunt ends
tech note	<b>single-terminated</b>
bus termination	one 78.7 ohm resistor
nominal unit weight	2.30 oz (65.20 g)

Part #	
<b>90-50663-12</b>	
Feature	Specification
bus & stub jacks	12" M17/176-00002 blunt ends
tech note	<b>dual-terminated</b>
bus termination	two 78.7 ohm resistor
nominal unit weight	1.90 oz (53.86 g)



**90-50253-12**



**90-50263-12**



**90-50363-12**



**90-50463-12**



**90-50563-12**



**90-50663-12**

## 4-Stub Inline Bus Couplers

Part #	
<b>90-50254-12</b>	
Feature	Specification
bus & stub jacks	12" M17/176-00002 blunt ends
tech note	<b>non-terminated</b>
bus termination	none
nominal unit weight	3.10 oz (87.88 g)

Part #	
<b>90-50364-12</b>	
Feature	Specification
bus & stub jacks	12" M17/176-00002 blunt ends
tech note	<b>single-terminated</b>
bus termination	one 78.7 ohm resistor
nominal unit weight	2.70 oz (76.54 g)

Custom lengths and connectorization options are available.

Part #	
<b>90-50264-12</b>	
Feature	Specification
bus & stub jacks	12" M17/176-00002 blunt ends
tech note	<b>single-terminated</b>
bus termination	one 78.7 ohm resistor
nominal unit weight	2.70 oz (76.54 g)

Part #	
<b>90-50464-12</b>	
Feature	Specification
bus & stub jacks	12" M17/176-00002 blunt ends
tech note	<b>dual-terminated</b>
bus termination	one 78.7 ohm resistor
nominal unit weight	2.30 oz (65.20 g)

Part #	
<b>90-50564-12</b>	
Feature	Specification
bus & stub jacks	12" M17/176-00002 blunt ends
tech note	<b>dual-terminated</b>
bus termination	two 78.7 ohm resistor
nominal unit weight	2.30 oz (65.20 g)



**90-50254-12**



**90-50264-12**



**90-50364-12**



**90-50464-12**



**90-50564-12**



**90-50270**  
**90-50271**

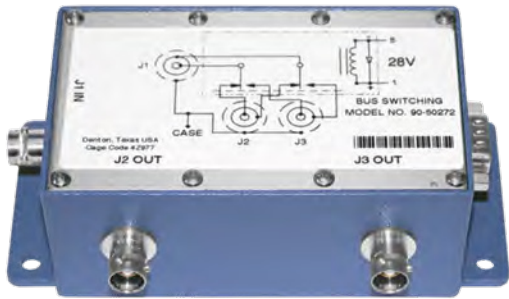

**90-50272**  
**90-50273**



**90-50274**  
**90-50275**

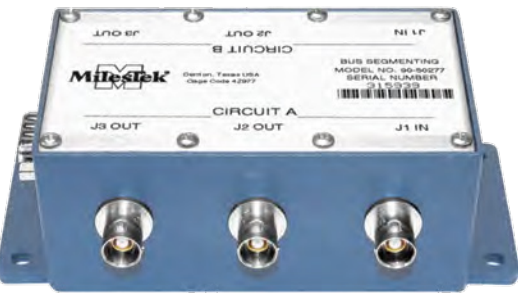

**90-50277**  
**90-50278**

## Stub Switching Relays

Part #		Part #	
<b>90-50270</b>		<b>90-50271</b>	
Feature	Specification	Feature	Specification
nominal coil voltage	28V	nominal coil voltage	5V
bus input jack	one TRB 3-lug jack	bus input jack	one TRB 3-lug jack
bus output jack	one TRB 3-lug jack	bus output jack	one TRB 3-lug jack
interface connector	DB9 male	interface connector	DB9 male

## Bus Switching Relays

Part #		Part #	
<b>90-50272</b>		<b>90-50273</b>	
Feature	Specification	Feature	Specification
nominal coil voltage	28V	nominal coil voltage	5V
bus input jack	one TRB 3-lug jack	bus input jack	one TRB 3-lug jack
bus output jack	two TRB 3-lug jack	bus output jack	two TRB 3-lug jack
interface connector	DB9 male	interface connector	DB9 male

## Bus Segmenting Relays

Part #		Part #	
<b>90-50274</b>		<b>90-50275</b>	
Feature	Specification	Feature	Specification
nominal coil voltage	28V	nominal coil voltage	5V
bus input jack	two TRB 3-lug jack	bus input jack	two TRB 3-lug jack
bus output jack	one TRB 3-lug jack	bus output jack	one TRB 3-lug jack
interface connector	DB9 male	interface connector	DB9 male

## Dual Bus Switching

Part #		Part #	
<b>90-50277</b>		<b>90-50278</b>	
Feature	Specification	Feature	Specification
nominal coil voltage	28V	nominal coil voltage	5V
bus input jack	two TRB 3-lug jack	bus input jack	two TRB 3-lug jack
bus output jack	four TRB 3-lug jack	bus output jack	four TRB 3-lug jack
interface connector	DB9 male	interface connector	DB9 male

Custom lengths and connectorization options are available.



# Kits, Bus/Scope Cables | MIL-STD-1553B

## Data Bus Coupler Kits - 2 Terminal & 4 Terminal

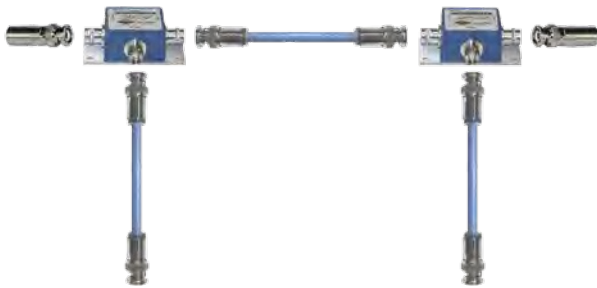

**Part #**

**TK-1037**

Quantity	Component	Part Number
2 each	1-stub bus couplers	90-50201
2 each	bus terminators	10-06403-025
1 each	bus cable assembly	CA-2009-72
2 each	stub cable assemblies	CA-2009-48

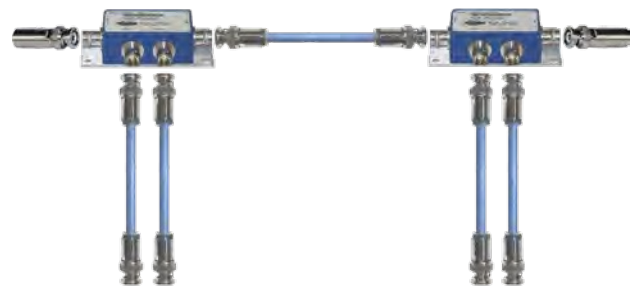

**Part #**

**TK-1038**

Quantity	Component	Part Number
2 each	2-stub bus couplers	90-50202
2 each	bus terminators	10-06403-025
1 each	bus cable assembly	CA-2009-72
2 each	stub cable assemblies	CA-2009-48

## Bus/Scope Test Cables



**Part #**

**CA-5111**

Feature	Specification
coaxial cable	75 ohm, 6.00 inches, BNC plugs
twinaxial cable	78 ohm, 60.00 inches, TRB plug



**Part #**

**CA-5112**

Feature	Specification
coaxial cable	75 ohm, 6.00 inches, BNC plugs
twinaxial cable	78 ohm, 10.00 inches, TRB plug

### Custom Bus Kits

MilesTek data bus coupler kits offer a complete solution to laboratory application requirements. Pre-assembled kits guarantee compatibility between various MIL-STD-1553B components. Custom data bus coupler kits are available.

### Bus/Scope Application

See application chart (right). Bus/scope test cables are typically used in laboratory testing environments. Bus/scope test cables are used with an oscilloscope to split and analyze individual signals on a bus.

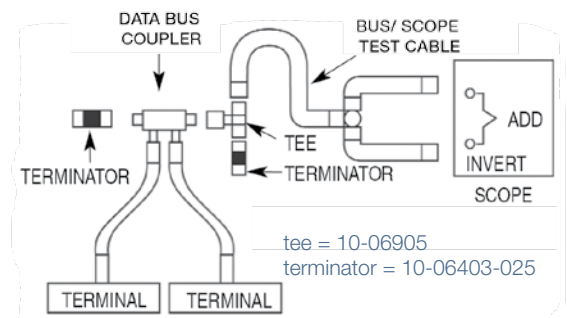

# MIL-STD-1553B | TVAC Cable Assemblies

## Vacuum Rated TVAC Twinaxial Cable Assemblies

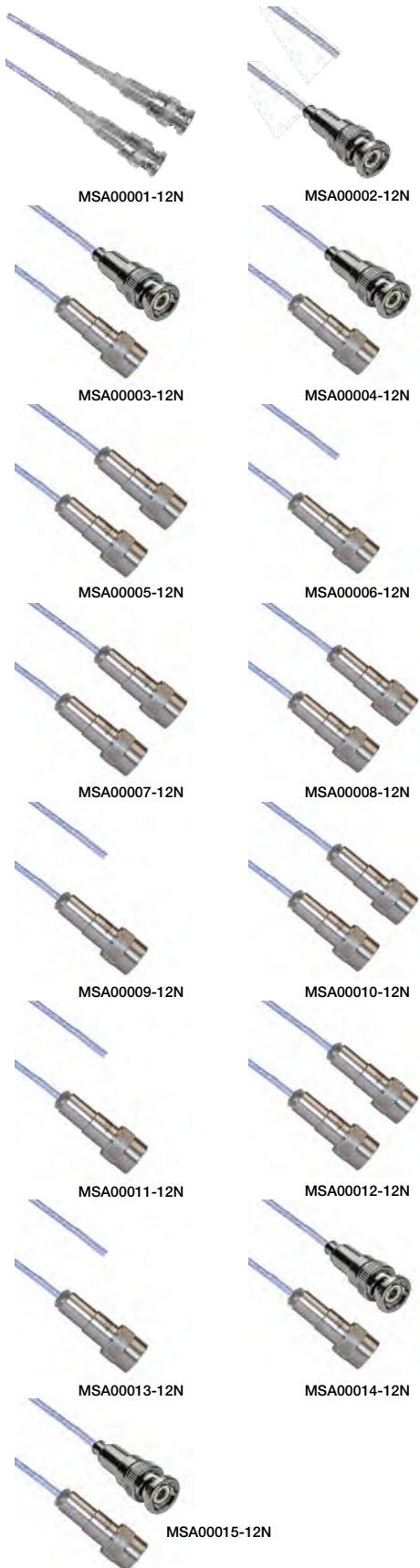

Item #	Description
<b>MSA00001-12N</b>	Vacuum Rated TVAC Twinaxial High Temp PFA Jacket 78 Ohm TRB 3 Slot Crimp Plug to TRB 3 Slot Crimp Plug .129" O.D. Cable Assembly -55C to +200C
<b>MSA00002-12N</b>	Vacuum Rated TVAC Twinaxial High Temp PFA Jacket 78 Ohm TRB 3 Slot Crimp Plug to Blunt .129" O.D. Cable Assembly -55C to +200C
<b>MSA00003-12N</b>	Vacuum Rated TVAC Twinaxial High Temp PFA Jacket 78 Ohm TRB 3 Slot Crimp Plug to TRS 3 Slot Crimp Plug .129" O.D. Cable Assembly -55C to +200C
<b>MSA00004-12N</b>	Vacuum Rated TVAC Twinaxial High Temp PFA Jacket 78 Ohm TRB 3 Slot Crimp Plug to TTM Threaded Crimp Plug .129" O.D. Cable Assembly -55C to +200C
<b>MSA00005-12N</b>	Vacuum Rated TVAC Twinaxial High Temp PFA Jacket 78 Ohm TRS 3 Slot Crimp Plug to TRS 3 Slot Crimp Plug .129" O.D. Cable Assembly -55C to +200C
<b>MSA00006-12N</b>	Vacuum Rated TVAC Twinaxial High Temp PFA Jacket 78 Ohm TRS 3 Slot Crimp Plug to Blunt .129" O.D. Cable Assembly -55C to +200C
<b>MSA00007-12N</b>	Vacuum Rated TVAC Twinaxial High Temp PFA Jacket 78 Ohm TRS 3 Slot Crimp Plug to TTM Threaded Crimp Plug .129" O.D. Cable Assembly -55C to +200C
<b>MSA00008-12N</b>	Vacuum Rated TVAC Twinaxial High Temp PFA Jacket 78 Ohm TTM Threaded Crimp Plug to TTM Threaded Crimp Plug .129" O.D. Cable Assembly -55C to +200C
<b>MSA00009-12N</b>	Vacuum Rated TVAC Twinaxial High Temp PFA Jacket 78 Ohm TTM Threaded Crimp Plug to Blunt .129" O.D. Cable Assembly -55C to +200C
<b>MSA00010-12N</b>	Vacuum Rated TVAC Twinaxial High Temp PFA Jacket 78 Ohm TCS Threaded Crimp Plug Pin to TCS Threaded Crimp Plug Pin .129" O.D. Cable Assembly -55C to +200C
<b>MSA00011-12N</b>	Vacuum Rated TVAC Twinaxial High Temp PFA Jacket 78 Ohm TCS Threaded Crimp Plug Pin to Blunt .129" O.D. Cable Assembly -55C to +200C
<b>MSA00012-12N</b>	Vacuum Rated TVAC Twinaxial High Temp PFA Jacket 78 Ohm TCS Threaded Crimp Plug Skt to TCS Threaded Crimp Plug Skt .129" O.D. Cable Assembly -55C to +200C
<b>MSA00013-12N</b>	Vacuum Rated TVAC Twinaxial High Temp PFA Jacket 78 Ohm TCS Threaded Crimp Plug Socket to Blunt .129" O.D. Cable Assembly -55C to +200C
<b>MSA00014-12N</b>	Vacuum Rated TVAC Twinaxial High Temp PFA Jacket 78 Ohm TRB 3 Slot Crimp Plug to TCS Threaded Crimp Plug Pin .129" O.D. Cable Assembly -55C to +200C
<b>MSA00015-12N</b>	Vacuum Rated TVAC Twinaxial High Temp PFA Jacket 78 Ohm TRB 3 Slot Crimp Plug to TCS Threaded Crimp Plug Socket .129" O.D. Cable Assembly -55C to +200C

See our website, [MilesTek.com](http://MilesTek.com) to view all of our products.

# Plenum Twinax Assemblies | MIL-STD-1553B

## TRB Plenum Cable Assemblies

Item #	Description
MSA00032-12N	Plenum Cable Assembly TRB 3-Slot Plug to Plug MIL-STD-1553 .150" O.D. +125C 78 Ohm Twinaxial Shielded Twisted Pair 1'
MSA00033-12N	Plenum Cable Assembly TRB 3-Slot Plug to Blunt MIL-STD-1553 .150" O.D. +125C 78 Ohm Twinaxial Shielded Twisted Pair 1'
MSA00034-12N	Plenum Cable Assembly TRB 3-Slot Plug to 3-Lug Cable Jack MIL-STD-1553 .150" O.D. +125C 78 Ohm Twinaxial Shielded Twisted Pair 1'
MSA00035-12N	Plenum Cable Assembly TRB 3-Slot Plug to Non-Insulated Bulk Head 3-Lug Cable Jack MIL-STD-1553 .150" O.D. +125C 78 Ohm Twinaxial Shielded Twisted Pair 1'
MSA00036-12N	Plenum Cable Assembly TRB 3-Slot Plug to Insulated Bulk Head 3-Lug Cable Jack MIL-STD-1553 .150" O.D. +125C 78 Ohm Twinaxial Shielded Twisted Pair 1'
MSA00037-12N	Plenum Cable Assembly TRB 3-Slot Plug to Plug with Bend Reliefs MIL-STD-1553 .150" O.D. +125C 78 Ohm Twinaxial Shielded Twisted Pair 1'
MSA00038-12N	Plenum Cable Assembly TRB 3-Slot Plug with Bend Relief to Blunt MIL-STD-1553 .150" O.D. +125C 78 Ohm Twinaxial Shielded Twisted Pair 1'
MSA00039-12N	Plenum Cable Assembly TRB 3-Slot Plug to 3-Lug Cable Jack with Bend Reliefs MIL-STD-1553 .150" O.D. +125C 78 Ohm Twinaxial Shielded Twisted Pair 1'
MSA00040-12N	Plenum Cable Assembly TRB 3-Slot Plug to Non-Insulated Bulk Head 3-Lug Cable Jack with Bend Reliefs MIL-STD-1553 .150" O.D. +125C 78 Ohm Twinaxial Shielded Twisted Pair 1'
MSA00041-12N	Plenum Cable Assembly TRB 3-Slot Plug to Insulated Bulk Head 3-Lug Cable Jack with Bend Reliefs MIL-STD-1553 .150" O.D. +125C 78 Ohm Twinaxial Shielded Twisted Pair 1'
MSA00042-12N	Plenum Cable Assembly TRB 3-Lug Cable Jack to Jack MIL-STD-1553 .150" O.D. +125C 78 Ohm Twinaxial Shielded Twisted Pair 1'
MSA00043-12N	Plenum Cable Assembly TRB Non-Insulated Bulk Head 3-Lug Cable Jack to Jack MIL-STD-1553 .150" O.D. +125C 78 Ohm Twinaxial Shielded Twisted Pair 1'
MSA00044-12N	Plenum Cable Assembly TRB Insulated Bulk Head Jack 3-Lug Cable Jack to Jack MIL-STD-1553 .150" O.D. +125C 78 Ohm Twinaxial Shielded Twisted Pair 1'
MSA00045-12N	Plenum Cable Assembly TRB 3-Lug Cable Jack to Jack with Bend Reliefs MIL-STD-1553 .150" O.D. +125C 78 Ohm Twinaxial Shielded Twisted Pair 1'
MSA00046-12N	Plenum Cable Assembly TRB Non-Insulated Bulk Head 3-Lug Cable Jack to Jack with Bend Reliefs MIL-STD-1553 .150" O.D. +125C 78 Ohm Twinaxial Shielded Twisted Pair 1'
MSA00047-12N	Plenum Cable Assembly TRB Insulated Bulk Head 3-Lug Cable Jack to Jack with Bend Relief MIL-STD-1553 .150" O.D. +125C 78 Ohm Twinaxial Shielded Twisted Pair 1'



See our website, [MilesTek.com](http://MilesTek.com) to view all of our products.



# MIL-STD-1553B | Lab Twinax Assemblies

## 30-02001 Cable - Lab-Rated Pvc, 0.242 Inch Overall Diameter

xxx = cable length in inches  
CA-2009-72 = 6 ft. (72 in.) CA-2009-xxx assembly



Connector	Part Number	Connector
10-06030-210 straight 3-slot solder/clamp plug	<b>CA-2009-xxx</b>	10-06030-210 straight 3-slot solder/clamp plug



Connector	Part Number	Connector
10-06030-210 straight 3-slot solder/clamp plug	<b>CA-2219-xxx</b>	blunt - no connector



Connector	Part Number	Connector
10-06030-210 straight 3-slot solder/clamp plug	<b>CA-2171-xxx</b>	10-06031-210 straight 3-slot solder/clamp plug



Connector	Part Number	Connector
10-06030-210 straight 3-slot solder/clamp plug	<b>MP-2177-xxx</b>	10-06575-210 straight 3-lug solder/clamp jack



Connector	Part Number	Connector
10-06030-210 straight 3-slot solder/clamp plug	<b>MP-2268-xxx</b>	10-06577-210 non-isolated 3-lug bulkhead jack



Connector	Part Number	Connector
10-06030-210 straight 3-slot solder/clamp plug	<b>MP-2192-xxx</b>	10-06573-210 isolated 3-lug bulkhead jack



Connector	Part Number	Connector
10-06575-210 straight 3-lug solder/clamp jack	<b>MP-2218-xxx</b>	10-06575-210 straight 3-lug solder/clamp jack



Connector	Part Number	Connector
10-06575-210 straight 3-lug solder/clamp jack	<b>MP-2275-xxx</b>	blunt - no connector

xxx = cable length in inches  
MP-2151-120 = 10 ft. (120 in.) MP-2151-xxx assembly



Connector	Part Number	Connector
10-06033-210 bend relief, straight 3-slot solder/clamp plug	<b>MP-2151-xxx</b>	10-06033-210 bend relief, straight 3-slot solder/clamp plug



Connector	Part Number	Connector
10-06033-210 bend relief, straight 3-slot solder/clamp plug	<b>MP-2156-xxx</b>	blunt - no connector



Connector	Part Number	Connector
10-06031-210 straight 3-slot full crimp plug	<b>MP-2357-xxx</b>	blunt - no connector



Connector	Part Number	Connector
10-06033-210 bend relief, straight 3-slot solder/clamp plug	<b>MP-2396-xxx</b>	10-06570-210 bend relief, straight 3-lug solder/clamp jack



Connector	Part Number	Connector
10-06033-210 bend relief, straight 3-slot solder/clamp plug	<b>MP-2624-xxx</b>	10-06579-210 non-isolated, bend relief 3-lug bulkhead jack



Connector	Part Number	Connector
10-06030-210 bend relief, straight 3-slot solder/clamp plug	<b>MP-2414-xxx</b>	10-06574-210 isolated, bend relief 3-lug bulkhead jack



Connector	Part Number	Connector
10-06570-210 bend relief, straight 3-lug solder/clamp jack	<b>MP-2540-xxx</b>	10-06570-210 bend relief, straight 3-lug solder/clamp jack



Connector	Part Number	Connector
10-06030-210 straight 3-slot solder/clamp plug	<b>CA-2253-xxx</b>	10-09030-210 straight threaded plug

# Lab Twinax Assemblies | MIL-STD-1553B

## 30-02003 Cable - Lab-Rated Pvc, 0.150 Inch Overall Diameter

xxx = cable length in inches  
CA-2014-72 = 6 ft. (72 in.) CA-2014-xxx assembly



Connector	Part Number	Connector
10-06030-231 straight 3-slot solder/clamp plug	<b>CA-2014-xxx</b> <b>MSA00470-03M</b>	10-06030-231 straight 3-slot solder/clamp plug



Connector	Part Number	Connector
10-06030-231 straight 3-slot solder/clamp plug	<b>MP-2017-xxx</b> <b>MSA00471-03M</b>	blunt - no connector



Connector	Part Number	Connector
10-06031-231 straight 3-slot full crimp plug	<b>MP-2352-xxx</b>	10-06031-231 straight 3-slot full crimp plug

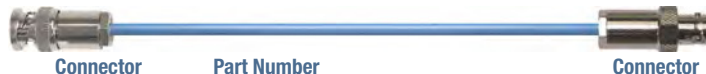

Connector	Part Number	Connector
10-06030-231 straight 3-slot solder/clamp plug	<b>CA-2257-xxx</b> <b>MSA00472-03M</b>	10-06575-231 straight 3-lug solder/clamp jack



Connector	Part Number	Connector
10-06030-231 straight 3-slot solder/clamp plug	<b>MP-2224-xxx</b> <b>MSA00473-03M</b>	10-06577-231 non-isolated 3-lug bulkhead jack



Connector	Part Number	Connector
10-06030-231 straight 3-slot solder/clamp plug	<b>MP-2310-xxx</b> <b>MSA00474-03M</b>	10-06573-231 isolated 3-lug bulkhead jack



Connector	Part Number	Connector
10-06575-231 straight 3-lug solder/clamp jack	<b>MP-2542-xxx</b> <b>MSA00480-03M</b>	10-06575-231 straight 3-lug solder/clamp jack



Connector	Part Number	Connector
10-06575-231 straight 3-lug solder/clamp jack	<b>MP-2442-xxx</b> <b>MSA00481-03M</b>	blunt - no connector

xxx = cable length in inches  
MP-2164-120 = 10 ft. (120 in.) MP-2164-xxx assembly



Connector	Part Number	Connector
10-06033-231 bend relief, straight 3-slot solder/clamp plug	<b>MP-2164-xxx</b> <b>MSA00475-03M</b>	10-06033-231 bend relief, straight 3-slot solder/clamp plug



Connector	Part Number	Connector
10-06033-231 bend relief, straight 3-slot solder/clamp plug	<b>MP-2347-xxx</b> <b>MSA00476-03M</b>	blunt - no connector



Connector	Part Number	Connector
10-06031-231 straight 3-slot full crimp plug	<b>MP-2358-xxx</b>	blunt - no connector



Connector	Part Number	Connector
10-06033-231 bend relief, straight 3-slot solder/clamp plug	<b>MP-2397-xxx</b> <b>MSA00477-03M</b>	10-06570-231 bend relief, straight 3-lug solder/clamp jack



Connector	Part Number	Connector
10-06033-231 bend relief, straight 3-slot solder/clamp plug	<b>MP-2625-xxx</b> <b>MSA00478-03M</b>	10-06579-231 non-isolated, bend relief 3-lug bulkhead jack



Connector	Part Number	Connector
10-06033-231 bend relief, straight 3-slot solder/clamp plug	<b>MP-2415-xxx</b> <b>MSA00479-03M</b>	10-06574-231 isolated, bend relief 3-lug bulkhead jack



Connector	Part Number	Connector
10-06570-231 bend relief 3-lug solder/clamp jack	<b>MP-2543-xxx</b> <b>MSA00486-03M</b>	10-06570-231 bend relief, straight 3-lug solder/clamp jack



Connector	Part Number	Connector
10-06570-231 bend relief, straight 3-lug solder/clamp jack	<b>MP-2544-xxx</b> <b>MSA00487-03M</b>	blunt - no connector

# MIL-STD-1553B | Vehicle Twinax Assemblies

## M17/176-00002 Cable - Vehicle High-Temp, 0.129 Inch Overall Diameter

xxx = cable length in inches  
CA-2008-72 = 6 ft. (72 in.) CA-2008-xxx assembly



Connector	Part Number	Connector
10-06030-206 straight 3-slot solder/clamp plug	<b>CA-2008-xxx</b> <b>MSA00436-03M</b>	10-06030-206 straight 3-slot solder/clamp plug



Connector	Part Number	Connector
10-06031-206 straight 3-slot solder/clamp plug	<b>CA-2430-xxx</b> <b>MSA00437-03M</b>	blunt - no connector



Connector	Part Number	Connector
10-06031-206 straight 3-slot full crimp plug	<b>CA-2001-xxx</b>	10-06031-206 straight 3-slot full crimp plug



Connector	Part Number	Connector
10-06032-206 right angle 3-slot full crimp plug	<b>MP-2166-xxx</b>	10-06031-206 straight 3-slot full crimp plug



Connector	Part Number	Connector
10-06030-206 straight 3-slot solder/clamp plug	<b>MP-2059-xxx</b> <b>MSA00438-03M</b>	10-06575-206 straight 3-lug solder/clamp jack



Connector	Part Number	Connector
10-06030-206 straight 3-slot solder/clamp plug	<b>MP-2252-xxx</b> <b>MSA00439-03M</b>	10-06577-206 non-isolated 3-lug bulkhead jack



Connector	Part Number	Connector
10-06030-206 straight 3-slot solder/clamp plug	<b>MP-2290-xxx</b> <b>MSA00440-03M</b>	10-06573-206 isolated 3-lug bulkhead jack



Connector	Part Number	Connector
10-06030-206 straight 3-slot solder/clamp plug	<b>CA-2416-xxx</b>	10-07030-206 straight 4-slot solder/clamp plug

xxx = cable length in inches  
MP-2165-120 = 10 ft. (120 in.) MP-2165-xxx assembly



Connector	Part Number	Connector
10-06030-206 straight 3-slot solder/clamp plug	<b>MP-2165-xxx</b> <b>MSA00441-03M</b>	10-06033-206 bend relief, straight 3-slot solder/clamp plug



Connector	Part Number	Connector
10-06033-206 bend relief, straight 3-slot solder/clamp plug	<b>CA-2342-xxx</b> <b>MSA00442-03M</b>	blunt - no connector



Connector	Part Number	Connector
10-06031-206 straight 3-slot full crimp plug	<b>MP-2359-xxx</b>	blunt - no connector



Connector	Part Number	Connector
10-06032-206 right angle 3-slot full crimp plug	<b>MP-2167-xxx</b>	10-06032-206 right angle 3-slot full crimp plug



Connector	Part Number	Connector
10-06033-206 bend relief, straight 3-slot solder/clamp plug	<b>MP-2398-xxx</b> <b>MSA00443-03M</b>	10-06570-206 bend relief, straight 3-lug solder/clamp jack



Connector	Part Number	Connector
10-06033-206 bend relief, straight 3-slot solder/clamp plug	<b>MP-2411-xxx</b> <b>MSA00444-03M</b>	10-06579-206 non-isolated, bend relief 3-lug bulkhead jack



Connector	Part Number	Connector
10-06575-206 straight 3-lug solder/clamp jack	<b>MP-2041-xxx</b> <b>MSA00446-03M</b>	10-06575-206 straight 3-lug solder/clamp jack



Connector	Part Number	Connector
10-06030-206 straight 3-slot solder/clamp plug	<b>MP-2377-xxx</b> <b>MSA00466-03M</b>	10-08030-206 straight 2-slot solder/clamp plug



# Vehicle Twinax Assemblies | MIL-STD-1553B

## 30-02002 Cable - Vehicle High-Temp, 0.095 Inch Overall Diameter

xxx = cable length in inches  
MP-2168-72 = 6 ft. (72 in.) MP-2168-xxx assembly

Connector	Part Number	Connector
10-06030-242 straight 3-slot solder/clamp plug	<b>MP-2168-xxx</b>	10-06030-242 straight 3-slot solder/clamp plug

Connector	Part Number	Connector
10-06030-242 straight 3-slot solder/clamp plug	<b>MP-2364-xxx</b>	blunt - no connector

Connector	Part Number	Connector
10-06030-242 straight 3-slot solder/clamp plug	<b>MP-2395-xxx</b>	10-06575-242 straight 3-lug solder/clamp jack

Connector	Part Number	Connector
10-06030-242 straight 3-slot solder/clamp plug	<b>MP-2623-xxx</b>	10-06577-242 non-isolated 3-lug bulkhead jack

Connector	Part Number	Connector
10-06030-242 straight 3-slot solder/clamp plug	<b>MP-2413-xxx</b>	10-06573-242 isolated 3-lug bulkhead jack

Connector	Part Number	Connector
10-06575-242 straight 3-lug solder/clamp jack	<b>MP-2545-xxx</b>	10-06575-242 straight 3-lug solder/clamp jack

Connector	Part Number	Connector
10-06575-242 straight 3-lug solder/clamp jack	<b>MP-2443-xxx</b>	blunt - no connector

xxx = cable length in inches  
MP-2360-120 = 10 ft. (120 in.) MP-2360-xxx assembly

Connector	Part Number	Connector
10-06033-242 bend relief, straight 3-slot solder/clamp plug	<b>MP-2360-xxx</b>	10-06033-242 bend relief, straight 3-slot solder/clamp plug

Connector	Part Number	Connector
10-06033-242 bend relief, straight 3-slot solder/clamp plug	<b>MP-2365-xxx</b>	blunt - no connector

Connector	Part Number	Connector
10-06033-242 bend relief, straight 3-slot solder/clamp plug	<b>MP-2399-xxx</b>	10-06575-242 bend relief, straight 3-lug solder/clamp jack

Connector	Part Number	Connector
10-06033-242 bend relief, straight 3-slot solder/clamp plug	<b>MP-2412-xxx</b>	10-06579-242 non-isolated, bend relief 3-lug bulkhead jack

Connector	Part Number	Connector
10-06033-242 bend relief, straight 3-slot solder/clamp plug	<b>MP-2417-xxx</b>	10-06574-242 isolated, bend relief 3-lug bulkhead jack

Connector	Part Number	Connector
10-06570-242 bend relief, straight 3-lug solder/clamp jack	<b>MP-2546-xxx</b>	10-06570-242 bend relief, straight 3-lug solder/clamp jack

Connector	Part Number	Connector
10-06570-242 bend relief, straight 3-lug solder/clamp jack	<b>MP-2547-xxx</b>	blunt - no connector



**Crimp Tools & Positioners**

page 28



**Bus Couplers**

pages 6-11



**RFI Caps**

page 11



**Adapters**

page 24

# MIL-STD-1553B | 78 Ohm Twinax Cable



**30-02001**

assemblies page 18



**30-02003**

assemblies pages 19, 27



**M17/176-00002**

assemblies pages 20, 26



**30-02002**

assemblies page 21

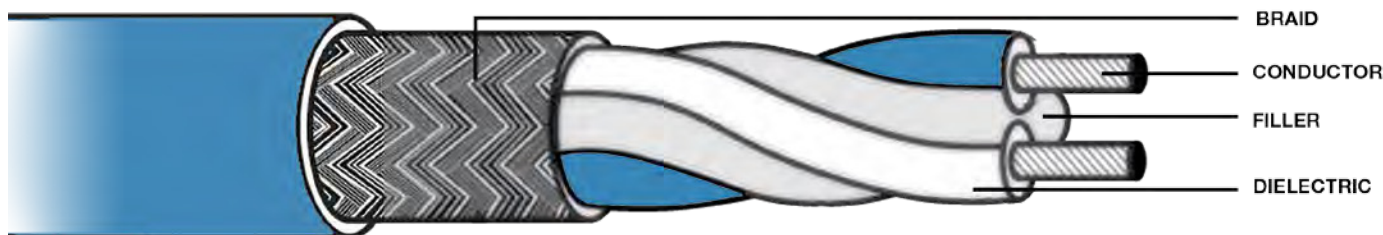

MilesTek	Lab-Rated Twinaxial Cable		Vehicle-Rated High-Temp Twinaxial Cable	
Cable Type Part Number	30-02001	30-02003		30-02002
uses MilesTek connector	-210	-231	-206	-242
<b>Specifications</b>				
nominal impedance (ohms)	78 ± 3	78 ± 3	77 ± 7	77 ± 7
nominal outer diameter (inches)	0.242	0.15	0.129	0.095
conductor diameter (inches)	0.037	0.022	0.024	0.0149
operating temperature range	-20°C to +75°C	-20°C to +75°C	-55°C to +200°C	-55°C to +200°C
minimum bend radius (inches)	2.42	1.5	1.5	1.25
nominal capacitance (pF/ft.)	19.7	20.3	24	23
outer jacket material	PVC	PVC	Teflon® FEP	PFA
insulation material	PVC	PVC	Teflon® FEP	FEP
shield coverage	0.93	0.93	0.93	0.9
<b>Attenuation (Db/100 Ft.)</b>				
1 MHz	0.6	2	1.4	2
3 MHz		3	2.1	
10 MHz	2.1	5.3	4.500 (max.)	6.5
20 MHz		7.5		
30 MHz		9.2		
40 MHz		10.6		
50 MHz	5	11.9		
100 MHz	7.5	16.8		
200 MHz	11	23.7		
400 MHz	16	--		
500 MHz		37.5		
700 MHz		44.3		
1000 MHz		53		

## Alternate Cable Options

Plenum, low smoke, high-temperature, and halogen-free bulk cable is also available. For any other bulk cable needs or requests, please contact MilesTek.

# Crimp Tools & Cable Splicing | MIL-STD-1553B

## TRB & TRS Bushing/Shield Crimp Tools - Compatible Set

Crimp Tool Description	Part Number
bushing/shield crimp handle	<b>M22520/5-01</b>
TRB crimp die set	<b>CD5-8</b> (Y778)
TRS crimp die set	<b>CD5-9</b> (Y687)



M22520/5-01



CD5-8 (Y778)



CD5-9 (Y687)

## TRB Center Contact Crimp Tools - Compatible Set

Crimp Tool Description	Part Number
center contact crimp handle	<b>M22520/1-01</b>
TRB center pin positioner	<b>010-0044</b> (TP837)
TRB center socket positioner	<b>010-0045</b> (TP838)



M22520/1-01



010-0044 (TP837)



010-0045 (TP838)

## TRS Submin Center Contact Crimp Tools - Compatible Set

Crimp Tool Description	Part Number
center contact crimp handle	<b>M22520/2-01</b>
TRS center pin positioner	<b>010-0041</b> (K815-S)



M22520/2-01



010-0041 (K815-S)

## M17/176-00002 Cable Splicing Tools - Compatible Set

Splicing Tool Description	Part Number
splice crimp tool	<b>AD-1377</b>
eight-piece splicing kit	<b>10-06950</b>

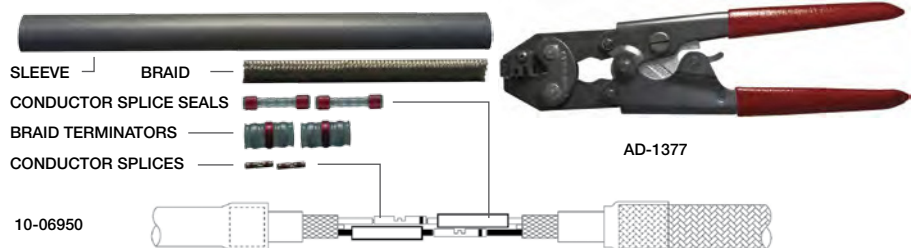

10-06950

AD-1377

## Crimp Tool Compatibility Guide

Full Crimp Connector Series	Cable Group	Cable Part Number	Bushing/Shield Crimp Handle	Bushing/Shield Crimp Die Set	Center Contact Crimp Handle	Center Contact Positioner
<b>TRB Standard</b> (full crimp - page 32)  10-06031-xxx 10-06032-xxx 10-06576-xxx	-210	30-02001 TWC-78-2 TWC-124-2	<b>M22520/5-01</b>	<b>CD5-8</b> (Y778)	<b>M22520/1-01</b>	<b>010-0044</b> (TP837) use for pin contacts (plugs)
	-231	30-02003 TWC-78-1 TWC-124-1A				<b>010-0045</b> (TP838) use for socket contacts (jacks)
	-206	M17/176-00002				
	-242	30-02002				
<b>TRS Subminiature</b> (full crimp - page 40)  10-10031-xxx 10-10032-xxx	-231	30-02003 TWC-78-1 TWC-124-1A	<b>M22520/5-01</b>	<b>CD5-9</b> (Y687)	<b>M22520/2-01</b>	<b>010-0041</b> (K815-S) use for pin (plugs) & socket (jacks) contacts
	-206	M17/176-00002				
	-242	30-02002				



# MIL-STD-1553B | TRB Connectors & Adapters

## TRB Cable Plug 3-Slot, Full Crimp



Compatible Twinax Cable Type	Straight	Right Angle
30-02001, TWC-78-2, TWC-124-2	<b>10-06031-210</b>	-
30-02003, TWC-78-1, TWC-124-1A	<b>10-06031-231</b>	-
M17/176-00002	<b>10-06031-206</b>	<b>10-06032-206</b>

Specifications - Dimensions	Straight	Right Angle
overall body width - inches (mm)	0.57" (14.50)	-
overall body length - inches (mm)	1.70" (43.18)	-
overall body height - inches (mm)	-	1.13" (28.70)

## TRB Bulkhead Jack To Solder Pot (Non-Isolated) Mating Options



Mating Interface	Front Mount	Rear Mount
3-lug female jack	<b>10-06569</b>	<b>10-06570</b>

Specifications - Dimensions	Front Mount	Rear Mount
mounting hole size - see chart below	D2.125	D3.218
overall body width - inches (mm)	0.56" (14.27)	0.69" (17.45)
overall body length - inches (mm)	1.12" (28.50)	1.31" (33.32)

## TRB Bulkhead Jack To Solder Pot (Isolated) Mating Options



Mating Interface	Front Mount	Rear Mount
3-lug female jack	<b>10-06571</b>	<b>10-06572</b>

Specifications - Dimensions	Front Mount	Rear Mount
mounting hole size - see chart below	D2.140	D2.140
overall body width - inches (mm)	0.87" (22.04)	0.87" (22.04)
overall body length - inches (mm)	1.37" (34.80)	1.37" (34.80)

## TRB Bulkhead Jack Feedthru (Isolated & Non-Isolated) Mating Options



Mating interface	Isolated	Non-isolated
3-lug female jack feedthru	<b>10-06568</b>	<b>10-06567</b>

  

Specifications - Dimensions	Isolated	Non-Isolated
mounting hole size - see chart below	D2.140	D3.187
overall body width - inches (mm)	0.80" (20.32)	0.73" (18.60)
overall body length - inches (mm)	1.29" (32.77)	1.29" (32.77)

## TRB Standard Within-Series Adapters



Description	Mating Interface	Adapter
TRB 3-lug jack to TRB 3-lug jack	feedthru female to female	<b>10-06901</b>
TRB 3-slot plug to two TRB 3-lug jacks	tee female-male-female	<b>10-06905</b>
TRB 3-slot plug to TRB 3-lug jack	right angle male to female	<b>10-06909</b>

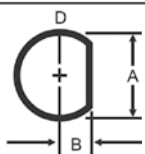

### Mounting Hole Sizes

**D1** = (A) 0.755-0.760" (B) 0.343-0.346"  
**D2** = (A) 0.630-0.635" (B) 0.281-0.284"  
**D3** = (A) 0.505-0.510" (B) 0.218-0.221"  
**D4** = (A) 0.439-0.443" (B) 0.187-0.190"

**D2.140**  
 maximum panel thickness in inches

**D5** = (A) 0.380-0.384" (B) 0.156-0.159"  
**D6** = (A) 0.317-0.321" (B) 0.128-0.131"  
**D7** = (A) 0.281-0.285" (B) 0.125-0.128"  
**D8** = (A) 0.439-0.443" (B) 0.187-0.190"  
**D9** = (A) 0.567-0.572" (B) 0.257-0.260"

**D7.250**  
 maximum panel thickness in inches

# TRB Connectors | MIL-STD-1553B

Plug	1 Pc. Price	Plug + Spring	Compatible Twinax Cable Type
10-06030-210	\$19.53	10-06033-210	30-02001, TWC-78-2, TWC-124-2
10-06030-231	\$19.35	10-06033-231	30-02003, TWC-78-1, TWC-124-1A
10-06030-206	\$19.35	10-06033-206	M17/176-00002
10-06030-242	\$19.72	10-06033-242	30-02002, TWAC-78-1F2
10-06030-227	\$19.91	10-06033-227	0024A0024-9X
Plug	Plug + Spring	Specifications - Dimensions	
0.57" (14.50)	0.57" (14.50)	overall body width - inches (mm)	
1.12" (28.50)	1.12" (28.50)	overall body length - inches (mm)	
-	1.85" (46.88)	spring length - inches (mm)	

TRB Cable Plug - 3-Slot, Solder/Clamp



10-06030-xxx

10-06033-xxx

Jack	1 Pc. Price	Jack + Spring	Compatible Twinax Cable Type
10-06575-210	\$29.28	10-06570-210	30-02001, TWC-78-2, TWC-124-2
10-06575-231	\$29.01	10-06570-231	30-02003, TWC-78-1, TWC-124-1A
10-06575-206	\$28.73	10-06570-206	M17/176-00002
10-06575-242	\$29.01	10-06570-242	30-02002, TWAC-78-1F2
Jack	Jack + Spring	Specifications - Dimensions	
0.57" (14.50)	0.57" (14.50)	overall body width - inches (mm)	
1.31" (33.40)	1.31" (33.40)	overall body length - inches (mm)	
-	1.85" (46.88)	spring length - inches (mm)	

TRB Cable Jack - 3-Lug, Solder/Clamp



10-06575-xxx

10-06570-xxx

Jack	1 Pc. Price	Jack + Spring	Compatible Twinax Cable Type
10-06577-210	\$32.79	10-06579-210	30-02001, TWC-78-2, TWC-124-2
10-06577-231	\$32.79	10-06579-231	30-02003, TWC-78-1, TWC-124-1A
10-06577-206	\$32.17	10-06579-206	M17/176-00002
10-06577-242	\$30.93	10-06579-242	30-02002, TWAC-78-1F2
Jack	Jack + Spring	Specifications - Dimensions	
D3.157	D3.157	mounting hole size - see chart pg 24	
0.69" (17.50)	0.69" (17.50)	overall body width - inches (mm)	
1.41" (35.81)	1.41" (35.81)	overall body length - inches (mm)	
-	1.85" (46.88)	spring length - inches (mm)	

TRB Bulkhead Cable Jack - 3-Lug, Solder/Clamp (Non-Isolated)



10-06577-xxx

10-06579-xxx

Jack	1 Pc. Price	Jack + Spring	Compatible Twinax Cable Type
10-06573-210	\$34.40		30-02001, TWC-78-2, TWC-124-2
10-06573-231	\$34.40	10-06574-231	30-02003, TWC-78-1, TWC-124-1A
10-06573-206	\$34.08		M17/176-00002
10-06573-242	\$32.45		30-02002, TWAC-78-1F2
Jack	Jack + Spring	Specifications - Dimensions	
D2.157	-	mounting hole size - see chart pg 24	
0.87" (22.04)	0.87" (22.04)	overall body width - inches (mm)	
1.41" (35.81)	-	overall body length - inches (mm)	
-	-	spring length - inches (mm)	

TRB Bulkhead Cable Jack - 3-Lug, Solder/Clamp (Isolated)



10-06573-xxx

10-06574-xxx

# SUBMINIATURE | Vehicle Twinax Assemblies

## M17/176-00002 Cable - Vehicle High-Temp, 0.129 Inch Overall Diameter

xxx = cable length in inches  
CA-2414-72 = 6 ft. (72 in.) CA-2414-xxx assembly

Connector	Part Number	Connector
10-10030-206 subminiature, straight 3-slot solder/clamp plug	<b>CA-2414-xxx</b> <b>MSA00456-03M</b>	10-06030-206 straight 3-slot solder/clamp plug

Connector	Part Number	Connector
10-10030-206 subminiature, straight 3-slot solder/clamp plug	<b>MP-3006-xxx</b>	10-06575-206 straight 3-lug solder/clamp jack

Connector	Part Number	Connector
10-10031-206 subminiature, straight 3-slot full crimp plug	<b>MP-2079-xxx</b>	10-06031-206 straight 3-slot full crimp plug

Connector	Part Number	Connector
10-10031-206 subminiature, straight 3-slot full crimp plug	<b>MP-2186-xxx</b>	blunt - no connector

Connector	Part Number	Connector
10-12030-206 subminiature, straight threaded plug	<b>MP-2006-xxx</b> <b>MSA00459-03M</b>	10-10030-206 subminiature, straight 3-slot solder/clamp plug

Connector	Part Number	Connector
10-12030-206 subminiature, straight threaded plug	<b>MP-5259-xxx</b> <b>MSA00461-03M</b>	blunt - no connector

Connector	Part Number	Connector
10-12031-206 subminiature, straight threaded full crimp plug	<b>MP-2485-xxx</b>	10-06031-206 straight 3-slot full crimp plug

xxx = cable length in inches  
MP-2134-120 = 10 ft. (120 in.) MP-2134-xxx assembly

Connector	Part Number	Connector
10-10030-206 subminiature, straight 3-slot solder/clamp plug	<b>MP-2134-xxx</b> <b>MSA00457-03M</b>	10-10030-206 subminiature, straight 3-slot solder/clamp plug

Connector	Part Number	Connector
10-10030-206 subminiature, straight 3-slot solder/clamp plug	<b>MP-2341-xxx</b> <b>MSA00458-03M</b>	blunt - no connector

Connector	Part Number	Connector
10-10031-206 subminiature, straight 3-slot full crimp plug	<b>CA-2095-xxx</b>	10-10031-206 subminiature, straight 3-slot full crimp plug

Connector	Part Number	Connector
10-12030-206 subminiature, straight threaded plug	<b>MP-2277-xxx</b> <b>MSA00460-03M</b>	10-12030-206 subminiature, straight threaded plug

Connector	Part Number	Connector
10-12030-206 subminiature, straight threaded plug	<b>MP-2004-xxx</b>	10-06030-206 straight 3-slot solder/clamp plug

Connector	Part Number	Connector
10-12031-206 subminiature, straight threaded full crimp plug	<b>MP-2096-xxx</b>	10-12031-206 subminiature, straight threaded full crimp plug

Connector	Part Number	Connector
10-12031-206 subminiature, straight threaded full crimp plug	<b>MP-2305-xxx</b>	blunt - no connector

### TRS Submin Cable Plug - 3-Slot, Solder/Clamp



10-10030-xxx

Compatible Twinax Cable Type	Plug
30-02003, TWC-78-1, TWC-124-1A	<b>10-10030-231</b>
M17/176-00002	<b>10-10030-206</b>
Specifications - Dimensions	Plug
overall body width - inches (mm)	0.46" (11.68)
overall body length - inches (mm)	0.83" (21.08)



# Lab Twinax Assemblies | SUBMINIATURE

## 30-02003 Cable - Lab-Rated Pvc, 0.150 Inch Overall Diameter

Assembly #	Cable Type	Application
CA-2005-xxx	30-02003	laboratory
MSA00490-03M	30-02003	laboratory

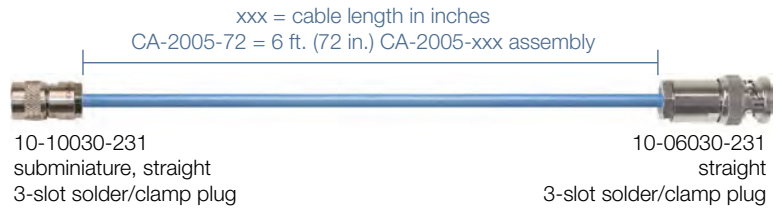

Assembly #	Cable Type	Application
CA-2375-xxx	30-02003	laboratory

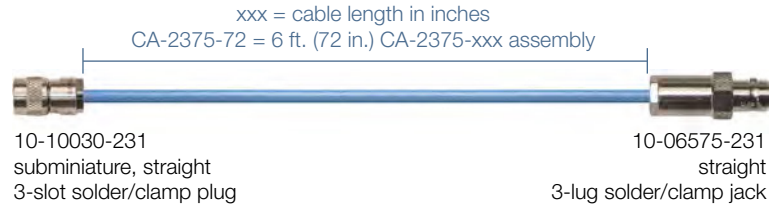

Assembly #	Cable Type	Application
MP-2474-xxx	30-02003	laboratory
MSA00493-03M	30-02003	laboratory

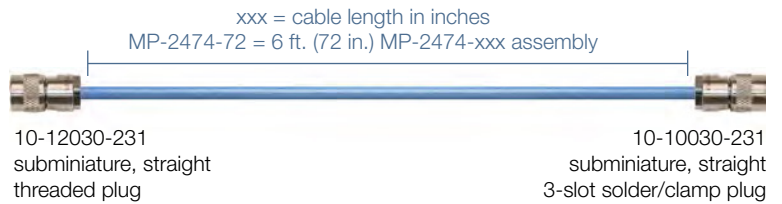

Assembly #	Cable Type	Application
MP-2478-xxx	30-02003	laboratory
MSA00495-03M	30-02003	laboratory

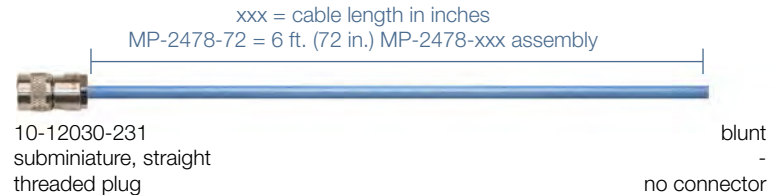

Assembly #	Cable Type	Application
MP-2018-xxx	30-02003	laboratory
MSA00491-03M	30-02003	laboratory

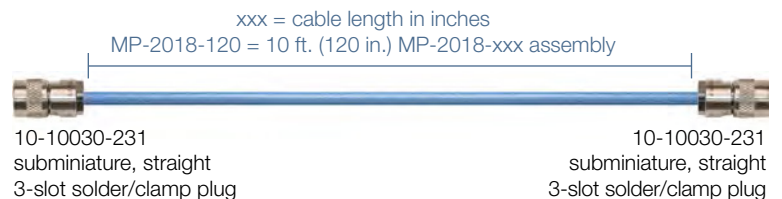

Assembly #	Cable Type	Application
MP-2456-xxx	30-02003	laboratory
MSA00492-03M	30-02003	laboratory

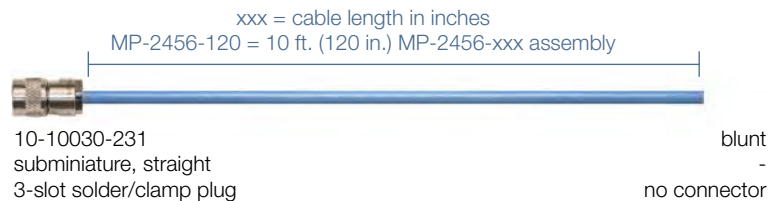

Assembly #	Cable Type	Application
MP-2098-xxx	30-02003	laboratory
MSA00494-03M	30-02003	laboratory

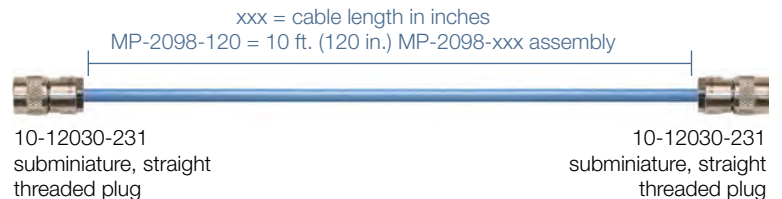

Assembly #	Cable Type	Application
MP-2229-xxx	30-02003	laboratory

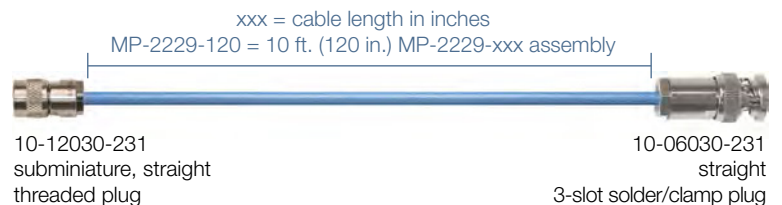

# SUBMINIATURE | TRS Crimp Tools, TRB v TRS



3-slot, 3-lug



2-slot, 2-lug



4-slot, 4-lug



threaded

## Mating Interfaces

Standard MilesTek TRB 3-slot plugs and TRB 3-lug jacks are the most common mating interfaces. MilesTek also offers connectors in 2-slot/lug, 4-slot/lug, and threaded mating interfaces. Call to request these alternate mating solutions.

## TRS Submin Center Contact Crimp Tools - Compatible Set



M22520/2-01



010-0041 (K815-S)

Crimp Tool Description	Part Number
center contact crimp handle	<b>M22520/2-01</b>
TRS center pin positioner	<b>010-0041</b> (K815-S)

## TRS Submin Crimp Tool Compatibility Guide

full crimp connector series	cable group	cable part number	bushing/shield crimp handle	bushing/shield crimp die set	center contact crimp handle	center contact positioner
<b>TRS subminiature</b> full crimp 10-10031-xxx 10-10032-xxx	-231	30-02003 TWC-78-1 TWC-124-1A	<b>M22520/5-01</b>	<b>CD5-9</b> (Y687)	<b>M22520/2-01</b>	<b>010-0041</b> (K815-S) use for pin (plugs) & socket (jacks) contacts
	-206	M17/176-00002				
	-242	30-02002				

## TRB Standard v. TRS Subminiature

### TRB Standard Connectors

Standard (TRB) connectors are designed for extreme durability and heavy-use applications. TRB connectors are the most common interface size (same size as BNC/TNC series). This connector series is not recommended for weight-sensitive applications. The maximum outer cable diameter is 0.475 inches (large-body versions are available for larger cables).

### TRS Subminiature Connectors

Subminiature (TRS) connectors are preferred in applications that require weight reduction, high packing density, and noise-free guarded circuits. TRS connectors can increase packing density to more than 240% compared to TRB standard connectors. The reduced size limits the maximum outer cable diameter to 0.250 inches.

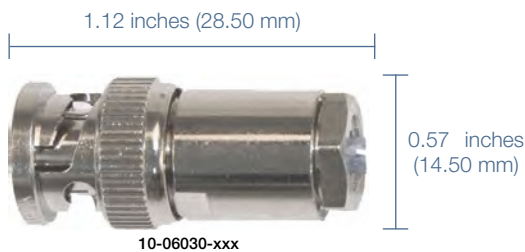

**3-SLOT  
TRB PLUG**



**3-SLOT  
TRS PLUG**

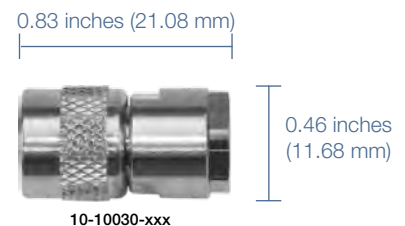

# 100 Ohm Twinax Cable | TWINAXIAL



**0024A0024-9X**  
assembly & components below

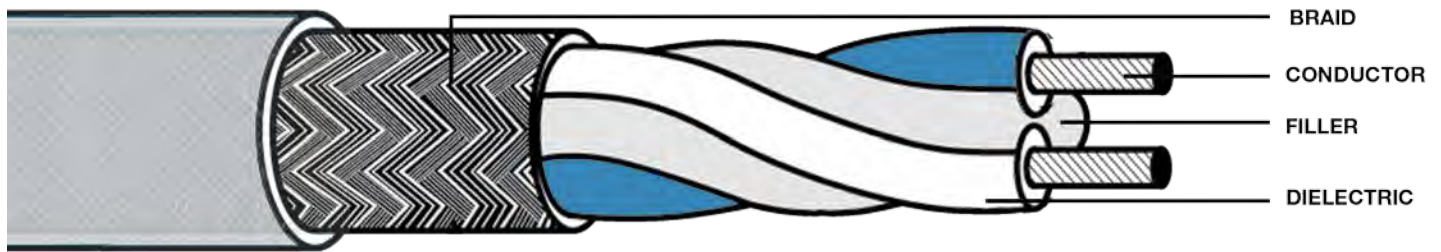

## MilesTek 100 Ohm Twinaxial Cable

<b>cable type part number</b>	<b>0024A0024-9X</b>
-------------------------------	---------------------

uses MilesTek connector	-227
-------------------------	------

### Specifications

nominal impedance (ohms)	100 ± 7
nominal outer diameter (inches)	0.149
conductor diameter (inches)	0.025
max. operating VDC	1000 V <sub>RMS</sub>
max. operating VAC (RMS)	1.0 kV
minimum bend radius (inches)	1.788
max. capacitance (pF/ft.)	13.5 (mutual)
outer jacket material	Modified FEP
insulation material	Rayfoam® H
shield coverage	90%

### Attenuation (dB/100 ft.)

1 MHz	0.300
3 MHz	
10 MHz	1.200
20 MHz	
30 MHz	
40 MHz	
50 MHz	2.800
100 MHz	4.100
200 MHz	6.400
400 MHz	10.200

## 100 Ohm TRB Plug To Plug Cable Assembly

xxx = cable length in inches  
MP-5771-120 = 10 ft. (120 in.) MP-5771-xxx assembly



Connector	Part Number	Connector
10-06030-227 straight 3-slot solder/clamp plug	<b>MP-5771-xxx</b>	10-06030-227 straight 3-slot solder/clamp plug

Prices shown for 12" length. See our website for additional lengths.

## 100 Ohm TRB Cable Plug - 3-Slot, Solder/Clamp



Compatible Twinax Cable Type	Plug
0024A0024-9X	<b>10-06030-227</b>

Specifications - Dimensions	Plug
overall body width - inches (mm)	0.57" (14.50)
overall body length - inches (mm)	1.12" (28.50)

# TWINAXIAL | 124 Ohm Twinax Cable



**TWC-124-2**  
assemblies page 31



**TWC-124-1A**  
assemblies page 31

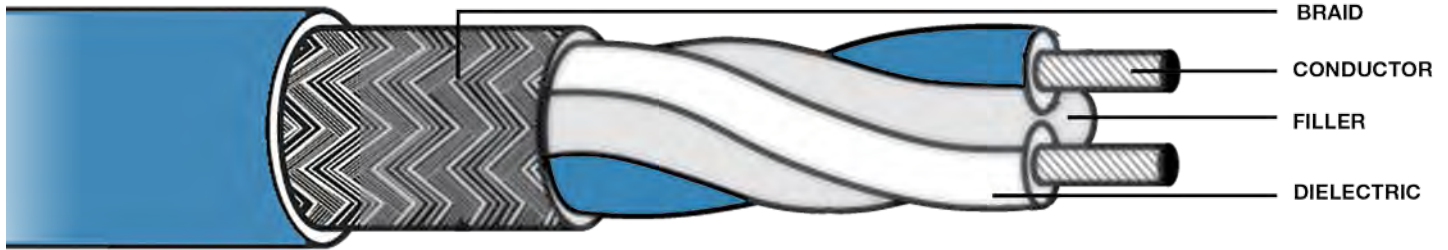

MilesTek 124 Ohm Twinaxial Cable		
Cable Type Part Number	TWC-124-2	TWC-124-1A
uses MilesTek connector	-210	-231
Specifications		
nominal impedance (ohms)	124 ± 4	124 ± 5
nominal outer diameter (inches)	0.245	0.150
conductor diameter (inches)	0.022	0.012
max. operating VDC	2.0 kV	0.6kV
max. operating VAC (RMS)	1.0 kV	0.3 kV
minimum bend radius (inches)	1.25	1.50
max. capacitance (pF/ft.)	12.30	12.40
outer jacket material	PVC	PVC
insulation material	PVC	PVC
shield coverage	93%	93%
Attenuation (dB/100 ft.)		
1 MHz	0.540	3.250
3 MHz	0.920	4.400
10 MHz	1.650	5.900
20 MHz	2.300	8.300
30 MHz	2.800	10.200
40 MHz	3.200	11.800
50 MHz	3.600	13.200
100 MHz	5.100	18.700
200 MHz	7.200	26.400
400 MHz	-	-
500 MHz	11.400	41.700
700 MHz	13.500	49.400

## Alternate Cable Options

Plenum, low smoke, high-temperature, and halogen-free bulk cable is also available upon request. For any other bulk cable needs or requests, please contact MilesTek.



# 124 Ohm Twinax Assemblies | TWINAXIAL

## TWC-124-2 cable PVC, 0.245 Inch Overall Diameter

xxx = cable length in inches  
MP-2205-72 = 6 ft. (72 in.) MP-2205-xxx assembly



Connector	Part Number	Connector
10-06030-210 straight 3-slot solder/clamp plug	<b>MP-2205-xxx</b>	10-06030-210 straight 3-slot solder/clamp plug



Connector	Part Number	Connector
10-06030-210 straight 3-slot solder/clamp plug	<b>MP-2302-xxx</b>	blunt - no connector



Connector	Part Number	Connector
10-06033-210 bend relief, straight 3-slot solder/clamp plug	<b>MP-2152-xxx</b>	10-06033-210 bend relief, straight 3-slot solder/clamp plug



Connector	Part Number	Connector
10-06030-210 straight 3-slot solder/clamp plug	<b>MP-2600-xxx</b>	10-06575-210 straight 3-lug solder/clamp jack



Connector	Part Number	Connector
10-06575-210 straight 3-lug solder/clamp jack	<b>MP-2601-xxx</b>	10-06575-210 straight 3-lug solder/clamp jack

## TWC-124-1A cable PVC, 0.150 Inch Overall Diameter

xxx = cable length in inches  
MP-2292-120 = 10 ft. (120 in.) MP-2292-xxx assembly



Connector	Part Number	Connector
10-06030-231 straight 3-slot solder/clamp plug	<b>MP-2292-xxx</b>	10-06030-231 straight 3-slot solder/clamp plug



Connector	Part Number	Connector
10-06030-231 straight 3-slot solder/clamp plug	<b>MP-2602-xxx</b>	blunt - no connector



Connector	Part Number	Connector
10-06033-231 bend relief, straight 3-slot solder/clamp plug	<b>MP-2487-xxx</b>	10-06033-231 bend relief, straight 3-lug solder/clamp jack



Connector	Part Number	Connector
10-10030-231 subminiature, straight 3-slot solder/clamp plug	<b>MP-2603-xxx</b>	10-10030-231 subminiature, straight 3-slot solder/clamp plug



Connector	Part Number	Connector
10-10030-231 subminiature, straight 3-slot solder/clamp plug	<b>MP-2344-xxx</b>	10-06030-231 straight 3-slot solder/clamp plug

### TRB Cable Plug - 3-Slot, Solder/Clamp

Compatible Twinax Cable Type	Plug
TWC-124-2	<b>10-06030-210</b>
TWC-124-1A	<b>10-06030-231</b>
Specifications - Dimensions	Plug
overall body width - inches (mm)	0.57" (14.50)
overall body length - inches (mm)	1.12" (28.50)



### TRB Cable Plug - 3-Slot, Bend Relief

Compatible Twinax Cable Type	Plug + Spring
TWC-124-2	<b>10-06033-210</b>
TWC-124-1A	<b>10-06033-231</b>
Specifications - Dimensions	Jack + Spring
overall body width - inches (mm)	0.57" (14.50)
overall body length - inches (mm)	1.12" (28.50)
spring length - inches (mm)	1.85" (46.88)



### TRB Cable Jack - 3-Lug, Solder/Clamp

Compatible Twinax Cable Type	Jack
TWC-124-2	<b>10-06575-210</b>
TWC-124-1A	<b>10-06575-231</b>
Specifications - Dimensions	Jack
overall body width - inches (mm)	0.57" (14.50)
overall body length - inches (mm)	1.31" (33.40)



### TRS Submin Plug - 3-Slot, Solder/Clamp

Compatible Twinax Cable Type	Plug
TWC-124-1A	<b>10-10030-231</b>
Specifications - Dimensions	Plug
overall body width - inches (mm)	0.46" (11.68)
overall body length - inches (mm)	0.83" (21.08)



# TWINAXIAL | 124 Ohm Twinax Assemblies

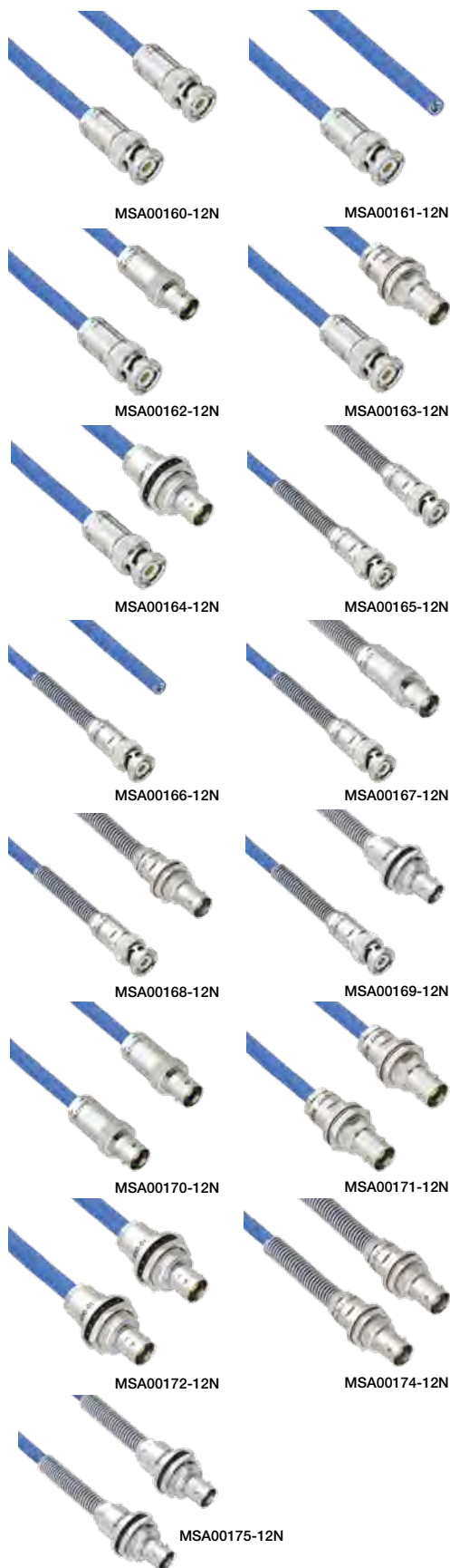

## Plenum Cable Assemblies

Item #	Description
<b>MSA00160-12N</b>	Plenum Cable Assembly TRB 3-Slot Plug to Plug .242" O.D. +125C 124 Ohm Twinaxial Shielded Twisted Pair 1'
<b>MSA00161-12N</b>	Plenum Cable Assembly TRB 3-Slot Plug to Blunt .242" O.D. +125C 124 Ohm Twinaxial Shielded Twisted Pair 1'
<b>MSA00162-12N</b>	Plenum Cable Assembly TRB 3-Slot Plug to 3-Lug Cable Jack .242" O.D. +125C 124 Ohm Twinaxial Shielded Twisted Pair 1'
<b>MSA00163-12N</b>	Plenum Cable Assembly TRB 3-Slot Plug to Non-Insulated Bulk Head 3-Lug Cable Jack .242" O.D. +125C 124 Ohm Twinaxial Shielded Twisted Pair 1'
<b>MSA00164-12N</b>	Plenum Cable Assembly TRB 3-Slot Plug to Insulated Bulk Head 3-Lug Cable Jack .242" O.D. +125C 124 Ohm Twinaxial Shielded Twisted Pair 1'
<b>MSA00165-12N</b>	Plenum Cable Assembly TRB 3-Slot Plug to Plug with Bend Reliefs .242" O.D. +125C 124 Ohm Twinaxial Shielded Twisted Pair 1'
<b>MSA00166-12N</b>	Plenum Cable Assembly TRB 3-Slot Plug with Bend Relief to Blunt .242" O.D. +125C 124 Ohm Twinaxial Shielded Twisted Pair 1'
<b>MSA00167-12N</b>	Plenum Cable Assembly TRB 3-Slot Plug to 3-Lug Cable Jack with Bend Reliefs .242" O.D. +125C 124 Ohm Twinaxial Shielded Twisted Pair 1'
<b>MSA00168-12N</b>	Plenum Cable Assembly TRB 3-Slot Plug to Non-Insulated Bulk Head 3-Lug Cable Jack with Bend Reliefs .242" O.D. +125C 124 Ohm Twinaxial Shielded Twisted Pair 1'
<b>MSA00169-12N</b>	Plenum Cable Assembly TRB 3-Slot Plug to Insulated Bulk Head 3-Lug Cable Jack with Bend Reliefs .242" O.D. +125C 124 Ohm Twinaxial Shielded Twisted Pair 1'
<b>MSA00170-12N</b>	Plenum Cable Assembly TRB 3-Lug Cable Jack to Jack .242" O.D. +125C 124 Ohm Twinaxial Shielded Twisted Pair 1'
<b>MSA00171-12N</b>	Plenum Cable Assembly TRB Non-Insulated Bulk Head 3-Lug Cable Jack to Jack .242" O.D. +125C 124 Ohm Twinaxial Shielded Twisted Pair 1'
<b>MSA00172-12N</b>	Plenum Cable Assembly TRB Insulated Bulk Head Jack 3-Lug Cable Jack to Jack .242" O.D. +125C 124 Ohm Twinaxial Shielded Twisted Pair 1'
<b>MSA00173-12N</b>	Plenum Cable Assembly TRB 3-Lug Cable Jack to Jack with Bend Reliefs .242" O.D. +125C 124 Ohm Twinaxial Shielded Twisted Pair 1'
<b>MSA00174-12N</b>	Plenum Cable Assembly TRB Non-Insulated Bulk Head 3-Lug Cable Jack to Jack with Bend Reliefs .242" O.D. +125C 124 Ohm Twinaxial Shielded Twisted Pair 1'
<b>MSA00175-12N</b>	Plenum Cable Assembly TRB Insulated Bulk Head 3-Lug Cable Jack to Jack with Bend Relief .242" O.D. +125C 124 Ohm Twinaxial Shielded Twisted Pair 1'

See our website, [MilesTek.com](http://MilesTek.com) to view all of our products.

# Twinaxial v Triaxial | REFERENCE

## Twinaxial Cable



### Description

Twinax cable is a two-conductor, twisted, balanced wire line with a specific impedance and a shielding braid around both wires.

### Technical Information

The twisting of the two balanced signal-carrying conductor wires cancels any random induced noise voltage pickup, giving protection against any low-frequency magnetic noise passing through the copper braid. Twinax cable is shielded, insulated from the twisted signal carrying conductors.

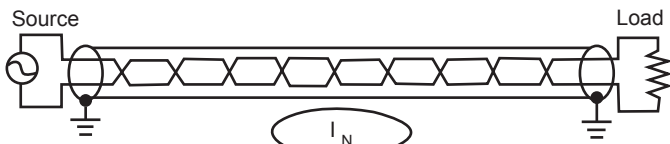

Twinax Cable Provides A Shield, Insulated From The Twisted Pair Signal Carrying Conductors

MilesTek's twinax cable design lowers cable losses by adding two dielectric fillers under the braid (separating the braid away from the signal pair), thereby lowering the leakage capacitance to ground. The coverage is improved to up to 93% by using more copper wire in the braid and weaving it tighter. This design also provides protection against ground loops and capacitive fields.

### Applications

Twinax cables are a cost-efficient and effective option for short-range, high-speed, differential signaling applications. For this reason, twinax is best suited for low-frequency digital and video distribution systems, like connecting MIL-STD-1553 bus and stub devices. Twinax cable is most effective up to approximately 15 MHz, since it has higher transmission losses above this frequency.



## Triaxial Cable



### Description

Triax cable is coax cable with an additional outer copper braid (insulated from the signal carrying conductors) which acts as a shield protecting the enclosed coax conductors.

### Technical Information

The outer braid is grounded and passes both ground loop and capacitive field noise currents away from the signal-carrying coax. This greatly improves the "signal-to-noise" ratio when compared to standard coax cable. In essence, triax cable provides additional shielding, insulated from the signal carrying coax.

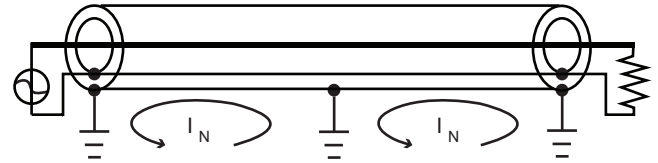

### Driven Shield

Triax cable is also used in "Driven Shield" (see diagram below) applications, where the inner conductor and the inner braid are driven in parallel at the transmitting end, and work against the outer braid which is insulated above ground. The inner braid creates a "Faraday" shield between the inner conductor and outer braid, as it is floating at the receiving end. Thus, the cable's distributed capacitance, cable losses and loading are greatly reduced.

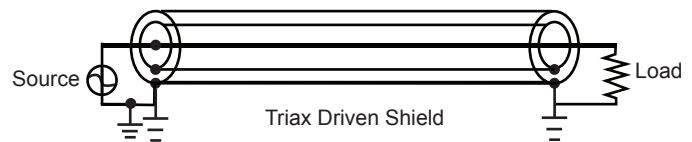

### Applications

Triax cables are effective for a broad range of applications, including high-frequency transducer data systems (where the distributed capacity in coax cable limits the data accuracy) and precision low-current measurements. Also, the two braids are useful as a low-impedance transmission line (approximately 12 ohms) to carry high-current pulses to low-impedance laser lamps or exploding bridge wire (EBW) ordinance systems.

# TRIAxIAL | 50 & 75 Ohm Triax Cable



**TRC-50-2**

assemblies page 35



**TRC-50-1**

assemblies page 35



**TRC-75-2**

assemblies page 38



**TRC-75-1**

assemblies page 38

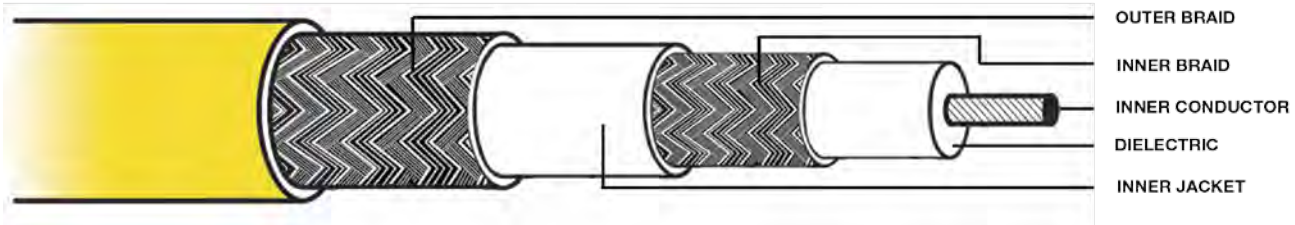

MilesTek	50 Ohm Triaxial Cable		75 Ohm Triaxial Cable	
Cable Type Part Number	TRC-50-2	TRC-50-1	TRC-75-2	TRC-75-1
uses MilesTek connector	-310	-370	-310	-350
<b>Specifications</b>				
nominal impedance (ohms)	50 ± 2	50 ± 2	75 ± 5	75 ± 5
nominal outer diameter (inches)	0.242	0.156	0.245	0.189
conductor diameter (inches)	0.037	0.015	0.185	0.012
max. operating VDC	6.0 kV	2.0 kV	6.0 kV	2.0 kV
max. operating VAC (RMS)	2.0 kV	1.0 kV	2.0 kV	1.0 kV
minimum bend radius (inches)	1.25	0.75	1.25	1.00
nominal capacitance (pF/ft.)	32.00	29.50	20.50	20.00
outer jacket material	PVC	PVC	PVC	PVC
insulation material	PVC	PVC	PVC	PVC
shield coverage	93%	93%	93%	93%
<b>Attenuation (dB/100 ft.)</b>				
1 MHz	0.500	2.800	0.480	0.900
3 MHz	0.800	3.100	0.880	1.300
10 MHz	1.500	4.100	1.500	2.400
20 MHz	2.300	5.500	2.300	3.600
30 MHz	2.900	7.000	2.900	4.500
40 MHz	3.400	7.500	3.300	5.400
50 MHz	3.900	9.100	3.600	6.100
100 MHz	5.800	14.000	5.200	9.700
200 MHz	8.800	22.000	7.600	16.500
400 MHz	-	-	-	-
500 MHz	15.300	40.000	10.800	28.500
700 MHz	18.000	50.000	14.700	36.000



# 50 Ohm Triax Assemblies | TRIAXIAL

## TRC-50-2 Cable

PVC, 0.242 Inch Overall Diameter

xxx = cable length in inches  
CA-3017-72 = 6 ft. (72 in.) CA-3017-xxx assembly



Connector	Part Number	Connector
10-06030-310 straight 3-slot solder/clamp plug	<b>CA-3017-xxx</b>	10-06030-310 straight 3-slot solder/clamp plug



Connector	Part Number	Price	Connector
10-06030-310 straight 3-slot solder/clamp plug	<b>MP-2604-xxx</b>	<b>\$106.29</b>	blunt - no connector



Connector	Part Number	Connector
10-06033-310 bend relief, straight 3-slot solder/clamp plug	<b>MP-2605-xxx</b>	10-06033-310 bend relief, straight 3-slot solder/clamp plug



Connector	Part Number	Connector
10-06030-310 straight 3-slot solder/clamp plug	<b>MP-2606-xxx</b>	10-06575-310 straight 3-lug solder/clamp jack



Connector	Part Number	Connector
10-06575-310 straight 3-lug solder/clamp jack	<b>MP-2607-xxx</b>	10-06575-310 straight 3-lug solder/clamp jack

## TRC-50-1 Cable

PVC, 0.156 Inch Overall Diameter

xxx = cable length in inches  
MP-2346-120 = 10 ft. (120 in.) MP-2346-xxx assembly



Connector	Part Number	Connector
10-06030-370 straight 3-slot solder/clamp plug	<b>MP-2346-xxx</b>	10-06030-370 straight 3-slot solder/clamp plug



Connector	Part Number	Connector
10-06030-370 straight 3-slot solder/clamp plug	<b>MP-2608-xxx</b>	blunt - no connector



Connector	Part Number	Connector
10-06030-370 straight 3-slot solder/clamp plug	<b>MP-2609-xxx</b>	10-06575-370 straight 3-lug solder/clamp jack



Connector	Part Number	Connector
10-10030-370 subminiature, straight 3-slot solder/clamp plug	<b>MP-2610-xxx</b>	10-10030-370 subminiature, straight 3-slot solder/clamp plug



Connector	Part Number	Connector
10-10030-370 subminiature, straight 3-slot solder/clamp plug	<b>MP-2611-xxx</b>	10-06030-370 straight 3-slot solder/clamp plug

## TRB Cable Plug - 3-Slot, Solder/Clamp

Compatible Triax Cable Type	Plug
TRC-50-2	<b>10-06030-310</b>
TRC-50-1	<b>10-06030-370</b>
Specifications - Dimensions	Plug
overall body width - inches (mm)	0.57" (14.50)
overall body length - inches (mm)	1.12" (28.50)



## TRS Submin Plug - 3-Slot, Solder/Clamp

Compatible Triax Cable Type	Plug
TRC-50-1	<b>10-10030-370</b>
Specifications - Dimensions	Plug
overall body width - inches (mm)	0.46" (11.68)
overall body length - inches (mm)	0.83" (21.08)



# TRIAxIAL | 50 Ohm Triax Assemblies

## Halogen Free Cable Assemblies



Item #	Description
<b>MSA00288-12N</b>	Halogen Free Cable Assembly with TRB 3-Slot Plug to Plug .245" O.D. -30C +80C 50 Ohm Triaxial Yellow 1'
<b>MSA00289-12N</b>	Halogen Free Cable Assembly TRB 3-Slot Plug to Blunt .245" O.D. -30C +80C 50 Ohm Triaxial Yellow 1'
<b>MSA00290-12N</b>	Halogen Free Cable Assembly TRB 3-Slot Plug to 3-Lug Cable Jack .245" O.D. -30C +80C 50 Ohm Triaxial Yellow 1'
<b>MSA00291-12N</b>	Halogen Free Cable Assembly TRB 3-Slot Plug to Non-Insulated Bulk Head 3-Lug Cable Jack .245" O.D. -30C +80C 50 Ohm Triaxial Yellow 1'
<b>MSA00292-12N</b>	Halogen Free Cable Assembly TRB 3-Slot Plug to Insulated Bulk Head 3-Lug Cable Jack .245" O.D. -30C +80C 50 Ohm Triaxial Yellow 1'
<b>MSA00293-12N</b>	Halogen Free Cable Assembly TRB 3-Slot Plug to Plug with Bend Reliefs .245" O.D. -30C +80C 50 Ohm Triaxial Yellow 1'
<b>MSA00294-12N</b>	Halogen Free Cable Assembly TRB 3-Slot Plug with Bend Relief to Blunt .245" O.D. -30C +80C 50 Ohm Triaxial Yellow 1'
<b>MSA00295-12N</b>	Halogen Free Cable Assembly TRB 3-Slot Plug to 3-Lug Cable Jack with Bend Reliefs .245" O.D. -30C +80C 50 Ohm Triaxial Yellow 1'
<b>MSA00296-12N</b>	Halogen Free Cable Assembly TRB 3-Slot Plug to Non-Insulated Bulk Head 3-Lug Cable Jack with Bend Reliefs .245" O.D. -30C +80C 50 Ohm Triaxial Yellow 1'
<b>MSA00297-12N</b>	Halogen Free Cable Assembly TRB 3-Slot Plug to Insulated Bulk Head 3-Lug Cable Jack with Bend Reliefs .245" O.D. -30C +80C 50 Ohm Triaxial Yellow 1'
<b>MSA00298-12N</b>	Halogen Free Cable Assembly TRB 3-Lug Cable Jack to Jack .245" O.D. -30C +80C 50 Ohm Triaxial Yellow 1'
<b>MSA00299-12N</b>	Halogen Free Cable Assembly TRB Non-Insulated Bulk Head 3-Lug Cable Jack to Jack .245" O.D. -30C +80C 50 Ohm Triaxial Yellow 1'
<b>MSA00300-12N</b>	Halogen Free Cable Assembly TRB Insulated Bulk Head Jack 3-Lug Cable Jack to Jack .245" O.D. -30C +80C 50 Ohm Triaxial Yellow 1'
<b>MSA00301-12N</b>	Halogen Free Cable Assembly TRB 3-Lug Cable Jack to Jack with Bend Reliefs .245" O.D. -30C +80C 50 Ohm Triaxial Yellow 1'
<b>MSA00302-12N</b>	Halogen Free Cable Assembly TRB Non-Insulated Bulk Head 3-Lug Cable Jack to Jack with Bend Reliefs .245" O.D. -30C +80C 50 Ohm Triaxial Yellow 1'
<b>MSA00303-12N</b>	Halogen Free Cable Assembly TRB Insulated Bulk Head 3-Lug Cable Jack to Jack with Bend Relief .245" O.D. -30C +80C 50 Ohm Triaxial Yellow 1'

See our website, [MilesTek.com](http://MilesTek.com) to view all of our products.

# 50 Ohm Triax Assemblies | TRIAXIAL

## Teflon Jacket Cable Assemblies

Item #	Description
MSA00352-12N	Teflon Jacket Cable Assembly with TRB 3-Slot Plug to Plug .236" O.D. -55C +200C 50 Ohm Triaxial 1'
MSA00353-12N	Teflon Jacket Cable Assembly TRB 3-Slot Plug to Blunt .236" O.D. -55C +200C 50 Ohm Triaxial 1'
MSA00354-12N	Teflon Jacket Cable Assembly TRB 3-Slot Plug to 3-Lug Cable Jack .236" O.D. -55C +200C 50 Ohm Triaxial 1'
MSA00355-12N	Teflon Jacket Cable Assembly TRB 3-Slot Plug to Non-Insulated Bulk Head 3-Lug Cable Jack .236" O.D. -55C +200C 50 Ohm Triaxial 1'
MSA00356-12N	Teflon Jacket Cable Assembly TRB 3-Slot Plug to Insulated Bulk Head 3-Lug Cable Jack .236" O.D. -55C +200C 50 Ohm Triaxial 1'
MSA00357-12N	Teflon Jacket Cable Assembly TRB 3-Slot Plug to Plug with Bend Reliefs .236" O.D. -55C +200C 50 Ohm Triaxial 1'
MSA00358-12N	Teflon Jacket Cable Assembly TRB 3-Slot Plug with Bend Relief to Blunt .236" O.D. -55C +200C 50 Ohm Triaxial 1'
MSA00359-12N	Teflon Jacket Cable Assembly TRB 3-Slot Plug to 3-Lug Cable Jack with Bend Reliefs .236" O.D. -55C +200C 50 Ohm Triaxial 1'
MSA00360-12N	Teflon Jacket Cable Assembly TRB 3-Slot Plug to Non-Insulated Bulk Head 3-Lug Cable Jack with Bend Reliefs .236" O.D. -55C +200C 50 Ohm Triaxial 1'
MSA00361-12N	Teflon Jacket Cable Assembly TRB 3-Slot Plug to Insulated Bulk Head 3-Lug Cable Jack with Bend Reliefs .236" O.D. -55C +200C 50 Ohm Triaxial 1'
MSA00362-12N	Teflon Jacket Cable Assembly TRB 3-Lug Cable Jack to Jack .236" O.D. -55C +200C 50 Ohm Triaxial 1'
MSA00363-12N	Teflon Jacket Cable Assembly TRB Non-Insulated Bulk Head 3-Lug Cable Jack to Jack .236" O.D. -55C +200C 50 Ohm Triaxial 1'
MSA00364-12N	Teflon Jacket Cable Assembly TRB Insulated Bulk Head Jack 3-Lug Cable Jack to Jack .236" O.D. -55C +200C 50 Ohm Triaxial 1'
MSA00365-12N	Teflon Jacket Cable Assembly TRB 3-Lug Cable Jack to Jack with Bend Reliefs .236" O.D. -55C +200C 50 Ohm Triaxial 1'
MSA00366-12N	Teflon Jacket Cable Assembly TRB Non-Insulated Bulk Head 3-Lug Cable Jack to Jack with Bend Reliefs .236" O.D. -55C +200C 50 Ohm Triaxial 1'
MSA00367-12N	Teflon Jacket Cable Assembly TRB Insulated Bulk Head 3-Lug Cable Jack to Jack with Bend Relief .236" O.D. 55C +200C 50 Ohm Triaxial 1'

See our website, [MilesTek.com](http://MilesTek.com) to view all of our products.



# TRIAXIAL | 75 Ohm Triax Assemblies

## Trc-75-2 Cable Pvc, 0.245 Inch Overall Diameter

xxx = cable length in inches

CA-3013-72 = 6 ft. (72 in.) CA-3013-xxx assembly



Connector	Part Number	Connector
10-06030-310 straight 3-slot solder/ clamp plug	<b>CA-3013-xxx</b>	10-06030-310 straight 3-slot solder/clamp plug

## Trc-75-1 Cable Pvc, 0.189 Inch Overall Diameter

xxx = cable length in inches

MP-3000-120 = 10 ft. (120 in.) MP-3000-xxx assembly



Connector	Part Number	Connector
10-06030-350 straight 3-slot solder/clamp plug	<b>MP-3000-xxx</b>	10-06030-350 straight 3-slot solder/clamp plug



Connector	Part Number	Connector
10-06030-310 straight 3-slot solder/clamp plug	<b>MP-2612-xxx</b>	blunt - no connector



Connector	Part Number	Connector
10-06030-350 straight 3-slot solder/clamp plug	<b>MP-2616-xxx</b>	blunt - no connector



Connector	Part Number	Connector
10-06030-310 bend relief, straight 3-slot solder/clamp plug	<b>MP-2613-xxx</b>	10-06030-310 bend relief, straight 3-slot solder/clamp plug



Connector	Part Number	Connector
10-06030-350 straight 3-slot solder/clamp plug	<b>MP-2617-xxx</b>	10-06575-350 straight 3-slot solder/clamp jack



Connector	Part Number	Connector
10-06030-310 straight 3-slot solder/clamp plug	<b>MP-2614-xxx</b>	10-06575-310 straight 3-slot solder/clamp jack



Connector	Part Number	Connector
10-10030-350 subminiature, straight 3-slot solder/clamp plug	<b>MP-2618-xxx</b>	10-10030-350 subminiature 3-slot solder/clamp plug



Connector	Part Number	Connector
10-06575-310 straight 3-lug solder/clamp jack	<b>MP-2615-xxx</b>	10-06575-310 straight 3-lug solder/clamp jack



Connector	Part Number	Connector
10-10030-350 subminiature, straight 3-slot solder/clamp plug	<b>MP-2619-xxx</b>	10-06030-350 straight 3-slot solder/clamp plug

### TRB Cable Plug - 3-Slot, Solder/Clamp

Compatible Triax Cable Type	Plug
TRC-75-2	<b>10-06030-310</b>
TRC-75-1	<b>10-06030-350</b>
Specifications - Dimensions	Plug
overall body width - inches (mm)	0.57" (14.50)
overall body length - inches (mm)	1.12" (28.50)



### TRS Submin Plug - 3-Slot, Solder/Clamp

Compatible Triax Cable Type	Plug
TRC-75-1	<b>10-10030-350</b>
Specifications - Dimensions	Plug
overall body width - inches (mm)	0.46" (11.68)
overall body length - inches (mm)	0.83" (21.08)





# LSZH Cable Assemblies/Connectors | D-SUBMINIATURE

## LSZH Cable Assemblies

Item #	Description
DSA00001-1F	LSZH D-Sub Cable, DB9 Male / DB9 Male
DSA00002-1F	LSZH D-Sub Cable, DB9 Male / DB9 Female
DSA00004-1F	LSZH D-Sub Cable, DB15 Male / DB15 Male
DSA00005-1F	LSZH D-Sub Cable, DB15 Male / DB15 Female
DSA00006-1F	LSZH D-Sub Cable, DB25 Male / DB25 Male
DSA00007-1F	LSZH D-Sub Cable, DB25 Male / DB25 Female

## Field Termination Connectors

Item #	Description
DSB00001	SVGA HD15 Jack for Field Termination
DSB00003	SVGA HD15 Plug for Field Termination
DSB00005	Mini Din 4 Female Field Termination Connector
DSB00006	DVI-D Dual Link Field Termination Connector
DSB00007	Female Field Termination Connector for HDMI Applications
DSB00008	3.5mm Field Termination Connector Female
DSB00106	DB9 Female Connector for Field Termination
DSB00108	DB15 Female Connector for Field Termination
DSB00110	HD15 Female Connector for Field Termination Panel Mount
DSB00114	DB9 Male Connector for Field Termination
DSB00116	DB15 Male Connector for Field Termination
DSB00118	HD15 Male Connector for Field Termination
DSB00123	DB15 Female Connector with Screwless Terminal Block
DSB00124	DB25 Female Connector with Screwless Terminal Block

## D-Sub Bulk Packaged Connectors - Crimp Style

Item #	Description
DSB00021	DB9 Male Crimp Connectors Tray, 50
DSB00022	DB15 Male Crimp Connectors Tray, 50
DSB00023	DB15 Female Crimp Connectors Tray, 50
DSB00024	DB25 Male Crimp Connectors Tray, 50
DSB00025	DB25 Female Crimp Connectors Tray, 50
DSB00026	DB37 Male Crimp Connectors Tray, 40
DSB00029	HD26 Male Solder Connectors Tray, 70

## D-Sub Bulk Packaged Connectors - Solder Style

Item #	Description
DSB00011	DB9 Male Solder Connectors Tray, 50
DSB00012	DB9 Female Solder Connectors Tray, 50
DSB00013	DB15 Male Solder Connectors Tray, 70
DSB00014	DB15 Female Solder Connectors Tray, 70
DSB00015	DB25 Male Solder Connectors Tray, 50
DSB00016	DB25 Female Solder Connectors Tray, 50
DSB00028	HD15 Female Solder Connectors Tray, 50
DSB00030	HD26 Female Solder Connectors Tray, 70

See our website, [MilesTek.com](http://MilesTek.com) to view all of our products.



DSA00002-F



DSA00005-F



DSA00007-F

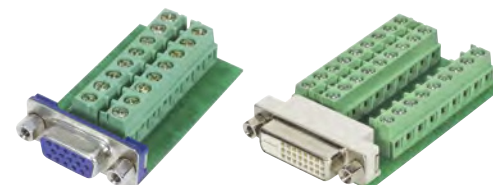

DSB00001

DSB00006

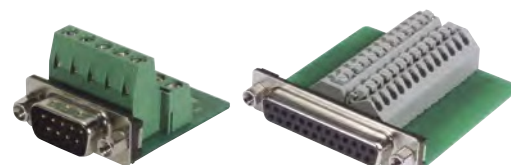

DSB00114

DSB00124



DSB00021

DSB00023

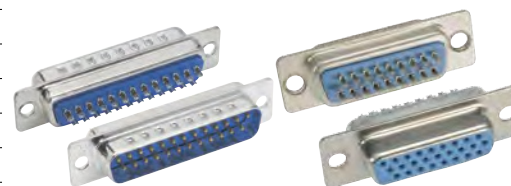

DSB00015

DSB00030

## D-Sub Cables | Top 5 Parts

Top 5 Parts	Description
DSA00012	Metal Armored DB9 M/F Cables Length 15ft
DSA00026	Heavy Duty DB15 M/F Cable 20AWG Length 10ft
DSA00028	Heavy Duty DB25 M/F Cable 20AWG Length 10ft
HAD00002	Deluxe HD15 M/F fully populated Length 10ft
HAD00001	Deluxe HD15 M/M fully populated Length 10ft



## D-Sub Connectors | Top 5 Parts

Top 5 Parts	Description
10-24150	DB9 Metal Hood W/5 Grommets
DSB00021	DB9 Male Solder Connectors Tray 50
DSB00033	Solder cup D-sub Connector DB25 Male
DSB00063	Crimp & Poke Male Pins Gold 30 Micro Inches pkg/10
DSB00100	Waterproof D-sub Backshell Kit DB15M



## Ethernet/M12 Cables | Top 5 Parts

Top 5 Parts	Description
T6A00007	Category 6a Aerospace Ethernet Cable High-Temp SF/UTP FEP Blue RJ45, 15.0 Feet
T5A00017	Category 5e Slim Aerospace Ethernet Cable High-Temp SF/UTP FEP Blue RJ45, 2.0 Feet
T5A00009	Category 5e M12 4 Position D code Double Shielded Industrial Cable, M12 M / M12 M, 10.0m
T5A00001	Industrial Grade Category 5E Double Shielded LSZH Patch Cord, 5.0 ft
T5A00002	Industrial Grade Category 5E Double Shielded LSZH Patch Cord, Black 2.0 ft



## Ethernet Adapters | Top 5 Parts

Top 5 Parts	Description
T6C00024	Category 6, Flange Mount, Electroless Nickel finish with Grounding Shield, Mounting Hardware & DC
T6C00004	Cat6 RJ45 Mini Coupler Shielded RJ45 (8x8) Panel Mount Style
T6C00016	Category 6, Ruggedized Flange Mount, Zinc-Nickel finish with Grounding Shield and Dust Cap
T5C00002	Cat5e RJ45 Coupler Shielded (8x8) Panel Mount Style
T5C00022	Ruggedized Jam-nut, Zinc-nickel finish with Grounding Shield and Dust Cap



T6C00024

## USB Cables/Connectors | Top 5 Parts

Top 5 Parts	Description
MUS2A00018	LSZH USB Cable Assembly, Latching A / Standard B 0.3m
MUS3A00030	USB 3.0 A/A METAL ARMOR CABLE 0.3M
MUS3A00044	USB 3.0 LSZH Type A/A Cable Assembly Length 1M
MUS3A00019	USB 3.0 A to A Metal Armored 0.3M
MUS3A00020	USB 3.0 Cable, Type B/A with Thumbscrew Hardware 2.0M

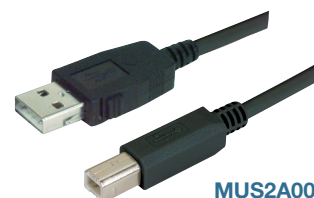

MUS2A00018

## GPIB Cables | Top 5 Parts

Top 5 Parts	Description
MGPA00001	Premium IEEE-488 Cable, Normal/Normal 0.3m
MGPA00006	Molded IEEE-488 Cable, Normal/Normal 1.0m
MGPA00005	Deluxe IEEE-488 Cable, 0.3m
MGPA00002	Premium IEEE-488 Cable, Normal/Inline 1.0m
MGPA00009	Molded IEEE-488 Cable, Normal/Inline 1.0m



MGPA00001

## SCSI Cables | Top 5 Parts

Top 5 Parts	Description
SZA00001	LSZH SCSI-3 Cable, HPDB68 Male/ HPDB68 Male, 3.0m
SZA00002	Ultra SCSI Cable, .8mm Male / HPDB68 Male, 2.0m
SZA00004	Ultra SCSI Cable, .8mm Male / Male, 2.0m
SZA00003	Ultra SCSI Cable, .8mm Male / HPDB50 Male, 2.0m
-	-



## A/V Cables | Top 5 Parts

Top 5 Parts	Description
MDA00015	DVI-D Single Link LSZH Cable Male/Male w/ Ferrites, 3.0 ft
MPDA00001	LSZH DisplayPort Cable Male-Male, Black - 1.0m
MMIA00005	HDMI Male to Male Active Extended Length Cable 10M
MDA00046	DVI-D Dual Link LSZH DVI Cable Male / Male Right Angle, Right 3.0 ft
MDA00014	Deluxe DVI-D Dual Link DVI Cable, Male/Male w/Ferrite 3.0 ft

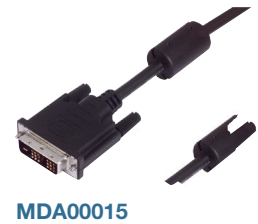

## AV Adapters | Top 5 Parts

Top 5 Parts	Description
10-03900	BNC Barrel Jack-Jack Adapter 7
10-03914	Goal Post Adapter 75 OHM
MDC00008	Blukhead Adapter DVI F/F
MDC00009	HDMI F/F Gender Changer
MDC00010	MilesTek DisplayPort Panel Mount Adapter (Female DP to Female DP)





## Fiber Optic Cables & Connectors | Top 5 Parts

Top 5 Parts	Description
FSA00001	9/125, IP67 Singlemode Fiber Cable, Dual LC / Dual LC, 1.0m
FSA00002	9/125 Single Mode, Military Fiber Cable, Dual LC / Dual LC, 2.0m
F1A00002	OM1 62.5/125, Military Fiber Cable, Dual LC / Dual LC, 1.0m
F2A00001	OM2 50/125, IP67 Multimode Fiber Cable, Dual LC / Dual LC, 1.0m
F2A00002	OM2 50/125, Military Fiber Cable, Dual LC / Dual LC, 3.0m



Top 5 Parts	Description
FYK00004	Cap for IP66/67 Duplex Fiber LC Plug
FYKB00007	Duplex LC IP66/67 Connector/Integrated Strain Relief
FYB00008	Duplex SM LC IP66/67 Connector/Integrated Strain Relief
FYC00005	IP66/67 Multimode Fiber Industrial Duplex LC Outlet
FYC00006	IP66/67 Singlemode Industrial Duplex LC Outlet



## Racks & Panels | Top 5 Parts

Top 5 Parts	Description
JS-16D3SF13/BJ78	16 Port Panel with BJ78 Bulkhead Jacks
REF00255	1.75" (1U) 16 Port Jack Panel Insert Bulkhead Feed Through TRB 3 Lug Non Isolated
REF00284	1.75" (1U) x 19" Steel Panel with 16 N-Type
REF00270	3.5" Panel 32 TRB 3 Lug Isolated Feed Through
REF00022	Universal Sub-Panel, 4 Insulated BNC Feed-Thru Adapters



## Power Cords | Top 5 Parts

Top 5 Parts	Description
MPPA00011	Universal CPU Power Cord - Nema 5-15P to C13
MPPA00002	Heavy Duty CPU/PDU Power Cord - C14 to C13 - 15 A
MPPA00014	PC/PDU Power Cord - NEMA 5-15 to C15 - 15 Amp
MPPA00008	Server/PDU Power Cord - C20 to C19 - 20 A - Black
MPPA00009	Laptop Power Cord - NEMA 5-15P to C5 - 10 Amp







## Our Experts are Here to Help:



**Same-Day Shipping**  
On orders placed by 6:00 PM CT



**Secure Online Ordering**  
milestek.com  
sales@milestek.com



**Toll Free +1 (866) 524-1553**  
**Phone +1 (940) 484-9400**



**ISO 9001:2015**



**INFINITE**<sup>®</sup>  
ELECTRONICS, INC.

About Infinite Electronics:  
Infinite Electronics is a leading global supplier of electronic components serving the urgent needs of engineers through a family of highly recognized and trusted brands. Our portfolio of brands, including Pasternack, Fairview Microwave, L-com, MilesTek, ShowMe Cables, NavePoint, INC Installs, Integra Optics, PolyPhaser, Transtector, KP Performance Antennas, RadioWaves, and Aiconics are technology specialists that provide broad inventories offering engineering-grade products, expert technical support, and same-day shipping.

